



Fulfilling Real Expectations.



90  
1933 - 2023

European Company. Since 1933.





# HERZ

/ HERZ sanitary tapware is manufactured by using technologically elaborate processing devices at a modern production and development centre in Šmartno pri Litiji. More than 85 years of experience are the source of our knowledge and inspiration for creating and developing high-quality sanitary tapware, which is also confirmed by all major European Certificates.

/ HERZ Sanitärarmaturen werden in unserem modernen Produktions- und Entwicklungszentrum in Šmartno pri Litiji, Slowenien hergestellt. Modernste Technologien in Verbindung mit 85 Jahren Erfahrung sind die Elemente unserer Inspiration zur Entwicklung hochwertiger Sanitärarmaturen. Unser hoher Qualitätsanspruch wird durch alle relevanten europäischen Zertifikate bestätigt.

## MISSION

To recognise living trends in the environment in which we operate and develop products which are technologically advanced and technically elaborate, but yet simple and practical to use, as well as visually elaborate in detail, based on recognising the demands of users and the market.

## MISSION

Moderne Küchen- und Badarmaturen sind längst mehr als nur funktionale Wasserhähne. Unsere Produkte orientieren sich an den Bedürfnissen, Wünschen und Erwartungen unserer Kunden. Auf dieser Basis entwickeln wir Sanitärarmaturen, die technologisch fortschrittlich, technisch durchdacht, modern im Design und praktisch in der Anwendung sind.

/ Our sanitary fittings match all required European standards; SIST EN200, SIST EN246, SIST EN248, SIST EN817, SIST EN1112 and SIST EN1113.

/ Unsere Sanitärarmaturen erfüllen alle erforderlichen europäischen Normen: SIST EN200, SIST EN246, SIST EN248, SIST EN817, SIST EN1112 und SIST EN1113.

# ARMATUREN TAPWARE



/ HERZ sanitary tapware is present in 75 countries worldwide. New investments, technology and knowledge have enabled the growth of production and development since 1933. In the light of users' wishes, new trends and the increasingly demanding taste of our customers, the quality level of the HERZ sanitary tapware is constantly improving and getting close to the leading companies in this sector.



## VISION

HERZ would like to become one of the leading, internationally renowned manufacturers of sanitary tapware, distinguished by its technological perfection, practicality, environmental friendliness, top-notch quality and modern design at reasonable prices. We strive to recognise the trends and needs on markets in time, as well as develop them and use them in creating products with a recognisable visual concept and their own story.

## VISION

Unser Ziel ist es, einer der führenden, international renommierten Sanitärarmaturenhersteller zu werden, der sich durch technologische Perfektion, Praktikabilität, Umweltfreundlichkeit, erstklassige Qualität und modernes Design zu günstigen Preisen auszeichnet. Wir sind bestrebt, Trends und Marktanforderungen rechtzeitig zu erkennen, umzusetzen und weiter zu entwickeln, um einzigartige Produkte mit einem klar erkennbaren visuellen Konzept und individuellen Vorteilen zu kreieren.

/ HERZ Sanitärarmaturen werden aktuell in 75 Ländern vertrieben. Neue Investitionen, der Einsatz modernster Technologien und die Dynamik im Bereich Forschung & Entwicklung sind die Bausteine unseres Unternehmenserfolgs seit 1933. Kundenwünsche, Designansprüche und neue Trends beeinflussen maßgeblich unser Streben nach kontinuierlicher Steigerung des Qualitätsniveaus unserer Produkte. Unser Anspruch ist es, zu den Marktführern in diesem Segment zu gehören.



/ Reduce your water consumption and save with use of water saving set HERZ. The Eco set contains two ECO aerators that enable water flow of 6 l/minute and water flow regulator for the shower that enables the water flow of 9 l/minute. Eco set is possible to use at all lines of sanitary mixers HERZ.

/ Reduzieren Sie Ihren Wasserverbrauch und sparen Sie mit der Nutzung des HERZ-Wassersparsets. Das Eco-Set enthält zwei ECO-Perlatores mit einem Wasserdurchfluss von 6 l/min, und einen Wasserdurchflussregler für die Dusche mit einem Wasserdurchfluss von 9 l/min. Das Eco-Set kann bei allen HERZ-Sanitärarmaturen verwendet werden.



# ECOLOGY

# ÖKOLOGIE

## **ENVIRONMENTAL AWARENESS AND CONCERN**

A prudent consumption of sources and energy products, environmentally friendly production methods, as well as environmental concern, are a part of our social responsibility and awareness.

The use of environmentally friendly packaging and promotion materials represents only a part of our environmental awareness. This is followed by environmentally friendly production procedures: A modern galvanization line, wastewater management and re-use of waste materials.

In the spirit of environmental concern, we also place great emphasis on safety and energy conservation. Our products are, thus, characterised by the deliberate approach to water consumption savings, energy efficiency and, consequently, conservation of natural resources.

## **NACHHALTIGKEIT UND UMWELTSCHUTZ**

Ein nachhaltiger Umgang mit Ressourcen und Energie, umweltfreundliche Produktionsmethoden sowie Umweltschutz sind Teil unserer gesellschaftlichen Verantwortung.

Umweltschonende Produktionsverfahren, eine moderne Galvanisierung, Abwassermanagement und die Wiederverwertung von Abfallstoffen sowie der Einsatz umweltfreundlicher Verpackungs- und Werbematerialien sind für uns selbstverständlich und Teil unseres gelebten Verantwortungsbewusstseins.

Im Sinne des Umweltschutzes legen wir auch großen Wert auf Sicherheit und Energieeinsparung. Unsere Produkte zeichnen sich durch bewussten und effizienten Umgang mit Wasser und Energie und damit auch durch die Schonung der natürlichen Ressourcen aus.

# INDEX

|   |     |
|---|-----|
| <b>BATHROOM</b><br><b>BADEZIMMER</b>        | 10  |
| Design series                               | 12  |
| Classic series                              | 70  |
| <b>KITCHEN</b><br><b>KÜCHE</b>              | 92  |
| Design series                               | 94  |
| Classic series                              | 124 |
| <b>CONCEALED MIXERS</b><br><b>UNTERPUTZ</b> | 140 |
| <b>SHOWERS</b><br><b>DUSCHEN</b>            | 150 |
| <b>ACCESSORIES</b><br><b>ZUBEHÖR</b>        | 188 |



# LEGEND / LEGENDE



Only mixer  
Nur Armatur



With waste  
Abfluss



Angle valves  
Eckventile



With waste, angle valves  
Abfluss, Eckventile



With waste, siphon, angle valves  
Abfluss, Siphon, Eckventile



Low pressure version  
Niederdruckversion



Angle valves, low pressure version  
Eckventile, Niederdruckversion



Shower head, hose and wall holder  
Brausekopf, Brauseschlauch und Wandhalter



Shower head, hose and shower rail  
Brausekopf, Brauseschlauch und Brausestange



Head shower  
Kopfbrause



Mixer with different spout lengths  
Armaturen mit unterschiedlichen Auslauflängen



Mixer with eco cartridge  
Armaturen mit Ökopatrone



Mixer with medical handle  
Armaturen mit Medizinischem Handgriff



Concealed shower mixer  
Unterputz-Duscharmatur



Concealed shower mixer  
Unterputz-Duscharmatur



Rosette and handle  
Sichtteil

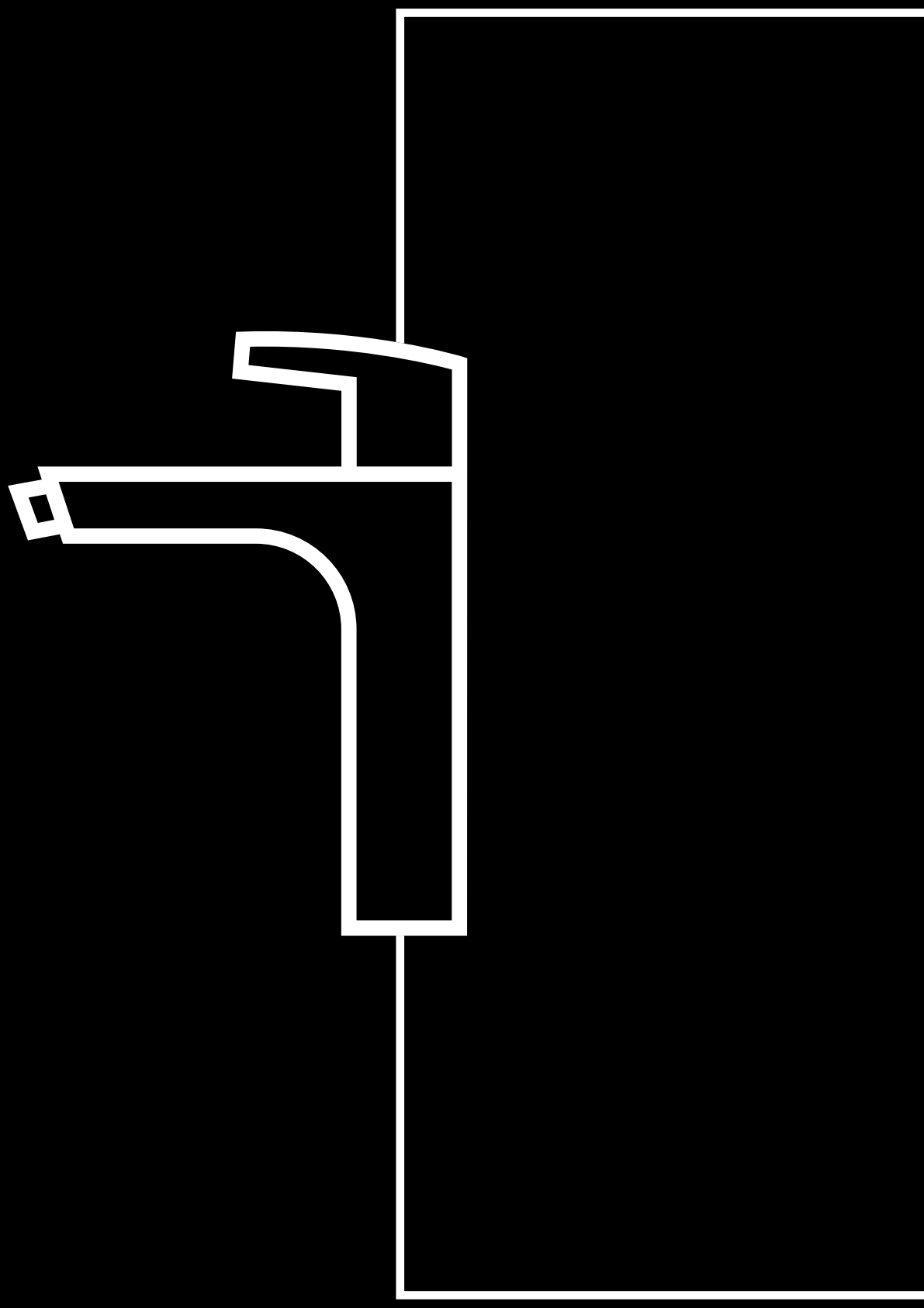

BATHROOM  
BADEZIMMER





# DESIGN SERIES

BATHROOM  
BADEZIMMER

# DESIGN SERIES



/ The Elite bathroom tapware stands out from the formal monotony with its elegant shape. In spite of the basic straight lines, the tapware, with its rounded soft transitions, complies with the strict architecture in the bathroom, as well as classic soft shapes. For an even more minimalist and exclusive appearance, you can choose the Elite flush-mounted washbasin tapware, as well as a rosette and handle for the built-in shower battery.



/ Bringen Sie Schwung in Ihre Wellness-Oase: mit der eleganten Form der Elite-Badarmaturen, die gekonnt Geradlinigkeit mit weichen, fließenden Übergängen verbindet –für die Fortsetzung strenger Linienführung aber auch bei der Verwendung von klassisch weichen Stilelementen in der Badarchitektur. Für eine noch minimalistischere und exklusivere Optik: Waschtischarmatur und Brausebatterie Elite mit Wandabdeckung und Bedienhebel für den Unterputz-Einbau oder die Vorwandinstallation.

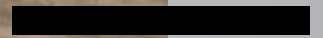



## Elite e12B

Basin mixer; higher version  
Waschbeckenarmatur; Version "erhöht"



00089B



/ Bath/shower mixers and shower mixers with shower set include water flow regulator that enables the water flow of 6 l/minute.  
/ Bad / Dusche Armaturen und Duscharmatur mit Duschgarnitur enthalten Wassermengenregler, die einen Wasserdurchfluss von 6 l/min ermöglichen.





## Elite e11B

Basin mixer  
Waschbeckenarmatur



00088B



## Elite e50B

Bidet mixer  
Bidetarmatur



00588B





## Elite e80B

Concealed basin mixer  
Unterputz-Waschtischbatterie



00080B

Note: 12705B – extension option  
Anmerkung: 12705B - Verlängerungsoption



## Elite e30B

Bath/shower mixer  
Wannen-/Duscharmatur



00373B

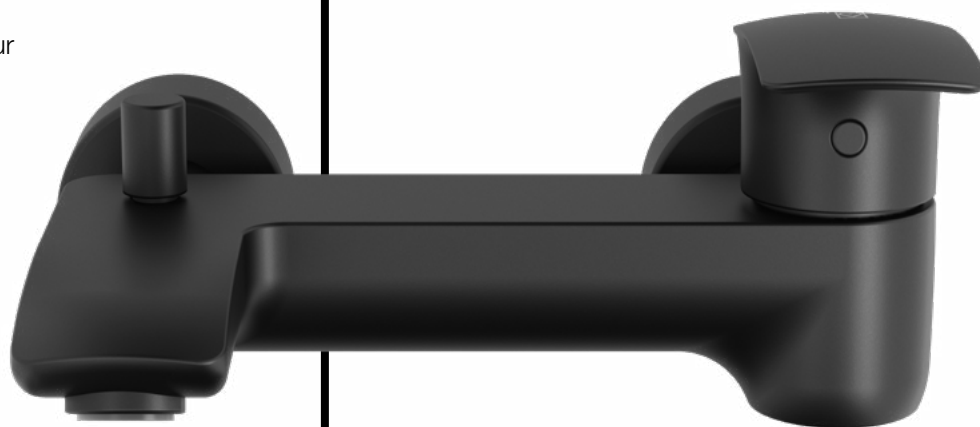

## Elite e40B

Shower mixer  
Duscharmatur



00485B

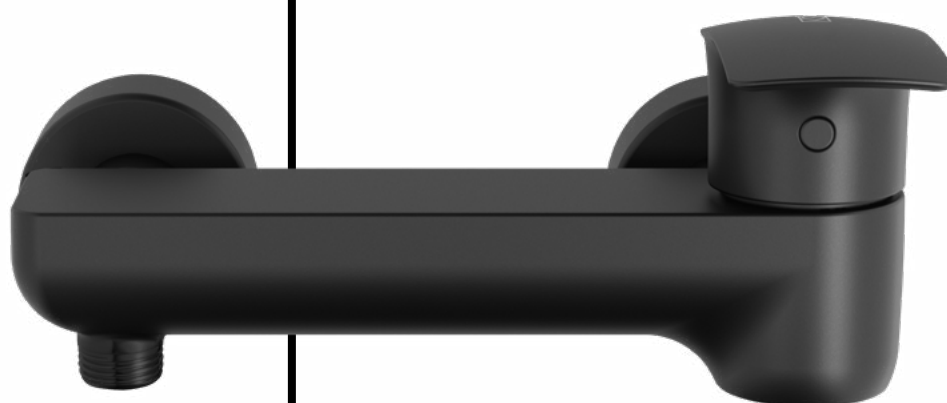



## Elite e12

Basin mixer; higher version  
Waschbeckenarmatur; Version "erhöht"



00089 00079 00090



/ Bath/shower mixers and shower mixers with shower set include water flow regulator that enables the water flow of 6 l/minute.  
/ Bad / Dusche Armaturen und Duscharmatur mit Duschgarnitur enthalten Wassermengenregler, die einen Wasserdurchfluss von 6 l/min ermöglichen.



## Elite e11

Basin mixer\*  
Waschbeckenarmatur\*



00088



00086



00087



00085



\* Also available: base for basin/bidet mixer,  
product no. 19219.

\* Auch erhältlich: Sockel für Waschtischbatterie,  
Artikelnummer 19219.

## Elite e50

Bidet mixer\*  
Bidetarmatur\*



00588



00586



\* Also available: base for basin/bidet mixer,  
product no. 19219.

\* Auch erhältlich: Sockel für Waschtischbatterie,  
Artikelnummer 19219.



## Elite e80

Concealed basin mixer  
Unterputz-Waschtischbatterie



00080

Note: 12705 - extension option  
Anmerkung: 12705 - Verlängerungsoption



## Elite e30

Bath/shower mixer  
Wannen-/Duscharmatur

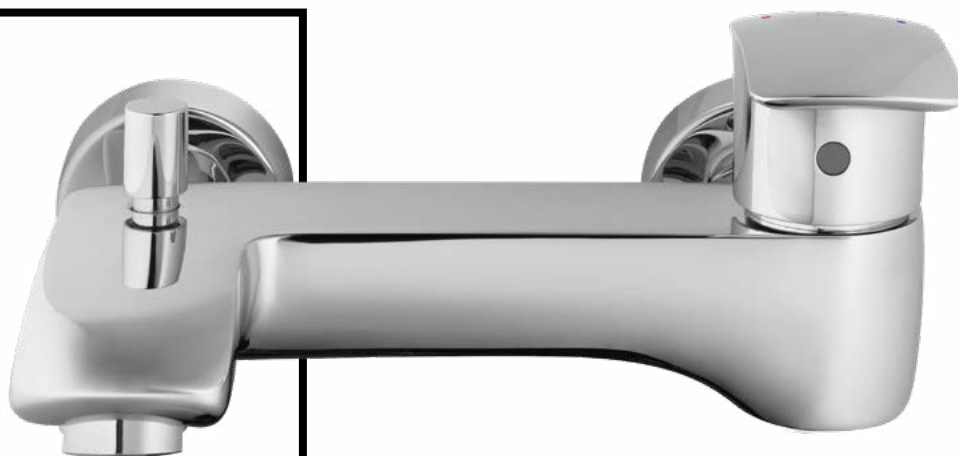

00373



00374



00375

## Elite e40

Shower mixer  
Duscharmatur

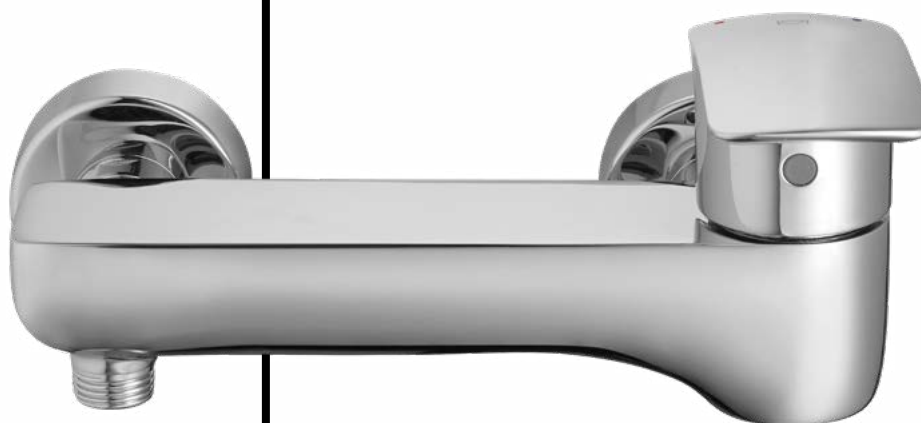

00485



00486



00487

# DESIGN SERIES

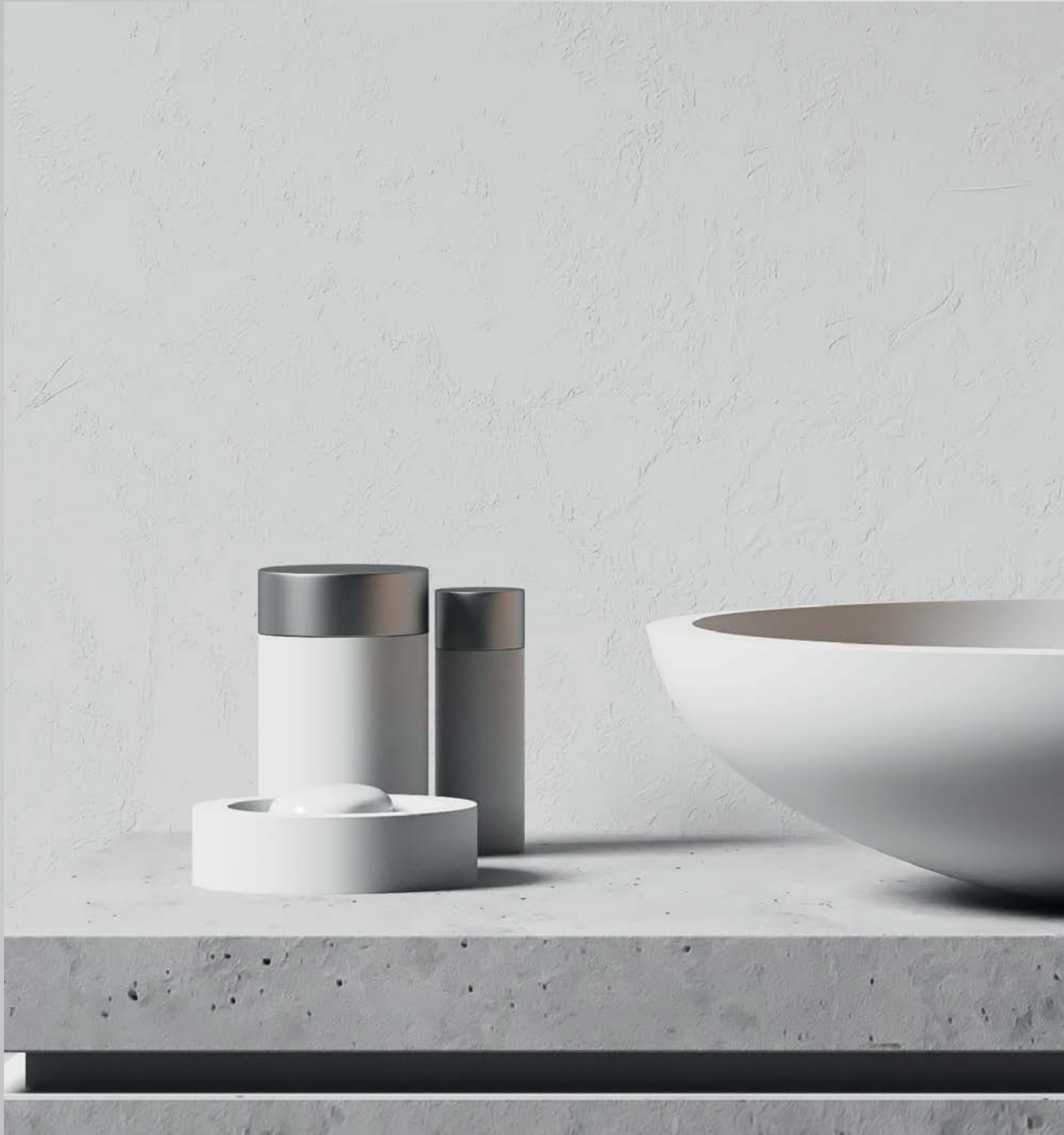

/ The SQ line is special due to its uniqueness, as this is the only bathroom tapware series characterised by completely square shapes. The top-notch design, which fits excellently into bathrooms with modern design and emphasis on details, is hidden in pure straight lines behind their apparent strictness. Top quality combined with usefulness and the elaborate image is what makes the SQ line unique.





/ Pure Geradlinigkeit mit scheinbarer Strenge: kantige Formen sind das Markenzeichen der SQ-Linie, die vor allem die Designansprüche moderner Bäder perfekt widerspiegeln. Die Kombination höchster Qualitätsansprüche, optimaler Handhabung und durchdachter Formgebung machen die SQ-Kollektion dabei so einzigartig.



# SQ q12B

Basin mixer; higher version  
Waschbeckenarmatur; Version "erhöht"



00058B



## SQ q11B

Basin mixer  
Waschbeckenarmatur



00057B



## SQ q50B

Bidet mixer  
Bidetarmatur



00595B





# SQ q30B

Bath/shower mixer  
Wannen-/Duscharmatur



00360B



29

## SQ q40B

Shower mixer  
Duscharmatur



00494B



# SQ q12

Basin mixer; higher version  
Waschbeckenarmatur; Version "erhöht"



00058



## SQ q11

Basin mixer  
Waschbeckenarmatur



00057



## SQ q50

Bidet mixer  
Bidetarmatur



00595





## SQ q30

Bath/shower mixer  
Wannen-/Duscharmatur



00360





33

## SQ q40

Shower mixer  
Duscharmatur



00494

# DESIGN SERIES



/ Soft curves and rounded shapes of Zen line are the right choice for those who love tradition, but at the same time appreciate modern design. The tapware also features a handle that is extremely pleasant to touch and allows precise water regulation. The Zen line is a perfect harmony of elegance and usability.



ZEN

/ Weiche Kurven und abgerundete Formen der Zen-Linie sind die richtige Wahl für diejenigen, die Tradition lieben und gleichzeitig modernes Design schätzen. Tapware verfügt auch über einen Griff, der sich sehr angenehm anfühlt. Die Zen-Linie ist ein perfekter Kompromiss zwischen Eleganz und Benutzerfreundlichkeit.



## Zen u11B

Basin mixer  
Waschbeckenarmatur



00077B



## Zen u50B

Bidet mixer  
Bidetarmatur



00530B



## Zen u30B

Bath/shower mixer  
Wannen-/Duscharmatur



00330B



37

## Zen u40B

Shower mixer  
Duscharmatur



00430B





## Zen u11

Basin mixer  
Waschbeckenarmatur



00077



## Zen u50

Bidet mixer  
Bidetarmatur



00530



## Zen u30

Bath/shower mixer  
Wannen-/Duscharmatur



00330



## Zen u40

Shower mixer  
Duscharmatur



00430



# DESIGN SERIES



**NEW**

/ The Lino range is a combination of straight and curved shapes that complement each other to create an elegantly simple look. The straight lines are the perfect solution for contemporary interiors, while the softer, rounded shapes are a great match for traditionally designed interiors. The mixer has a slightly raised handle design, making it even easier to operate.





O

N

L

L

/ Die Serie Lino ist eine Kombination aus geraden und abgerundeten Formen, die sich gegenseitig ergänzen und ein elegantes, schlichtes Aussehen schaffen. Die geraden Linien sind die perfekte Lösung für moderne Innenräume, während die weicheren, abgerundeten Formen gut zu traditionell gestalteten Räumen passen. Die Armatur ist mit einem leicht erhöhten Griff ausgestattet, der die Bedienung noch einfacher macht. Die Serie Lino wird Ihr Bad ästhetisch vervollständigen, denn sie umfasst eine Duscharmatur, eine Waschtischarmatur sowie eine Unterputzversion.



## Lino I12

Basin mixer; higher version  
Waschbeckenarmatur; Version "erhöht"

**NEW**



00096



## Lino I11

Basin mixer; higher version  
Waschbeckenarmatur; Version "erhöht"

**NEW**



00095



00078



## Lino I50

Bidet mixer  
Bidetarmatur

**NEW**



00590





## Lino I30

Bath/shower mixer  
Wannen-/Duscharmatur

**NEW**



00396

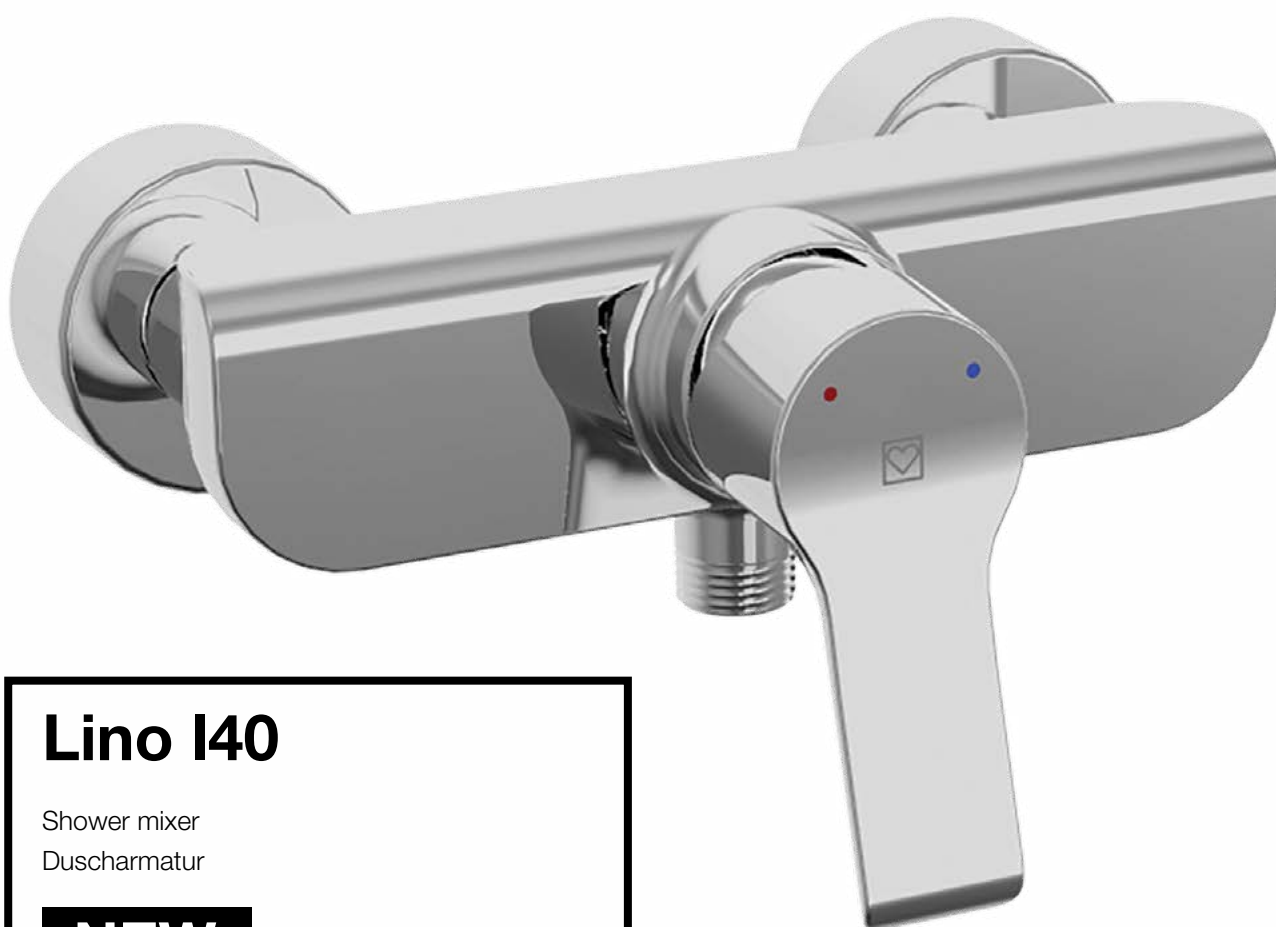

## Lino I40

Shower mixer  
Duscharmatur

**NEW**



00490

# DESIGN SERIES



/ Elegant combining of straight and curved lines supplemented with care for the environment by water saving ECO aerators, pampers you in your daily use. The mixer is fitted with an aerator of the highest quality that enables the water flow of 6 l per minute. INIFINITY basin mixer therefore represents an elegant and useful blend of modern design and care for the environment at the same time.



# KEY TECH NINE ELEMENTS

/ Die elegante Kombination von geraden und runden Linien im Einklang mit nachhaltigem Umweltschutz durch den Einsatz von wassersparenden ECO-Perlatores verwöhnt sie tagtäglich. Die Armatur ist mit einem Perlator höchster Qualität ausgestattet, welcher einen Wasserdurchfluss von 6 l/min ermöglicht. Die INFINITY Waschtischarmatur steht für eine gleichermaßen elegante und nützliche Vereinigung von modernem Design und Achtung der Umwelt.



## Infinity i11

Basin mixer; higher version  
Waschbeckenarmatur; Version "erhöht"



00014



00012



00013



00011



01012



01011



00053



## Infinity i10

Basin mixer\*  
Waschbeckenarmatur\*



00004



00002



00003



00001



/ All basin mixers include eco aerator that enables the water flow of 6 l/min.

/ Wannen-/Duscharmaturen und Duscharmaturen mit Duschgarnitur enthalten Wassermengenregler, die einen Wasserdurchfluss von 6 l/min ermöglichen.

\* Also available: base for basin/bidet mixer, product no. 19219.

\* Auch erhältlich: Sockel für Waschtischbatterie, Artikelnummer 19219.





## Infinity i50

Bidet mixer\*  
Bidetarmatur\*



00503



00501



\* Also available: base for basin/bidet mixer,  
product no. 19219.

\* Auch erhältlich: Sockel für Waschtischbatterie,  
Artikelnummer 19219.

## Infinity i01

Fittings with medical handle  
Armatur mit medizinischem Griff



00006



Note: length of handle 200 mm

Anmerkung: länge des Griffs 200 mm





## Infinity i30

Bath/shower mixer  
Wannen-/Duscharmatur



00301



00302



00303



00311



/ Bath/shower mixers and shower mixers with shower set include water flow regulator that enables the water flow of 9 l/minute.  
/ Wannen-/Duscharmaturen und Duscharmaturen mit Duschgarnitur enthalten Wassermengenregler, die einen Wasserdurchfluss von 9 l/min ermöglichen.



# Infinity i40

Shower mixer  
Duscharmatur



00401



00402



00403



00411



SETS  
SETS

## Infinity i100

SET

00059



12460



00012



00301

SETS  
SETS

# Infinity i101

SET

00060



00012



00401



12460

SETS  
SETS

## Infinity i102

SET

00069



12460



00002



00301

SETS  
SETS

# Infinity i103

SET

00070



00002



00401

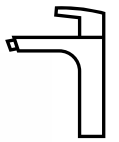

12460

# DESIGN SERIES



/ The Fresh line tapware can fit into every modern bathroom due to their modern, trendy round lines, elaborate details and various versions of washbasin tapware. These are elaborate products in terms of their design and function, providing satisfaction to their users with their design and daily use.















# FRESH

/ Die Waschtischarmaturen der Fresh-Line integrieren sich Dank ihrer trendig gerundeten Linien und aufwändigen Details in jedes moderne Badezimmer. Durchdacht in Design und Funktion setzen Fresh-Armaturen immer formschöne Akzente.



# Fresh f12

Basin mixer; higher version  
Waschbeckenarmatur; Version "erhöht"

|  |   |  |  |  |
|--|---|--|--|--|
| <br>150<br>mm | <br>150<br>mm | <br>200<br>mm | <br>200<br>mm | <br>150<br>mm |
|               |               |               |               |               |
| 00048  | 00049   | 00600  | 00601  | 00042  |



## Fresh f11

Basin mixer  
Waschbeckenarmatur



00039



00038



00040



00035



01035



01036



## Fresh f50

Bidet mixer  
Bidetarmatur



00537



00536



00535



00538





## Fresh f15

Basin mixer  
Waschbeckenarmatur



00045



00044



## Fresh f85

Flush-mounted basin mixer  
Unterputz-Waschtischarmatur

**NEW**



00034

Note: 12708 – extension option  
Anmerkung: 12708 - Verlängerungsoption



## Fresh f30

Bath/shower mixer  
Wannen-/Duscharmatur



00334



00337



00335

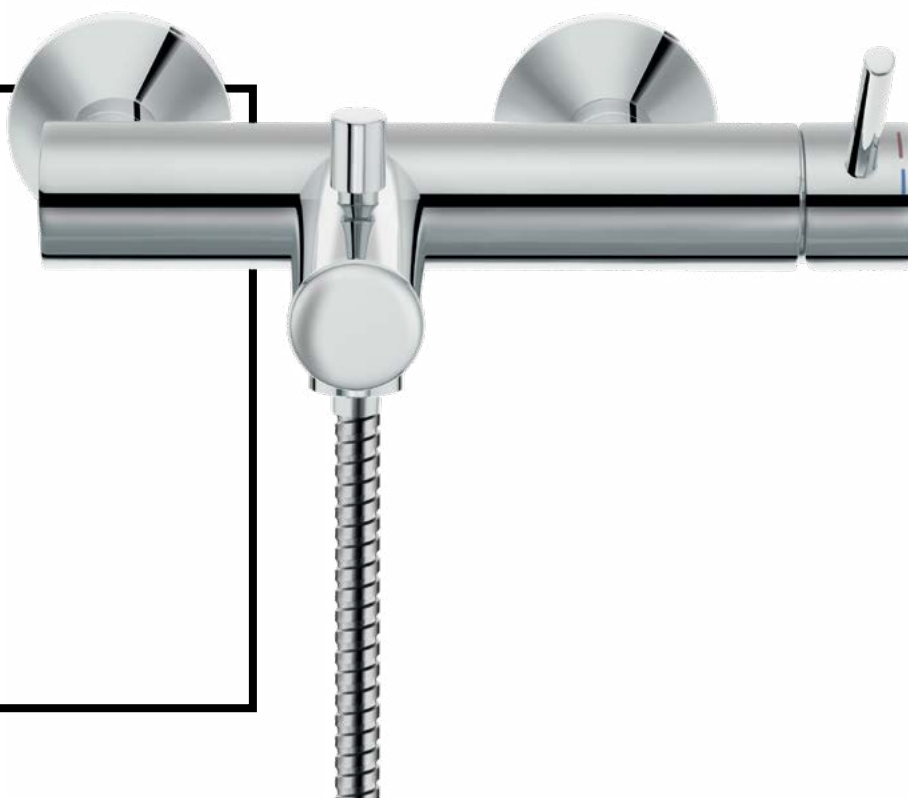

## Fresh f40

Shower mixer  
Duscharmatur



00434



00438



00435

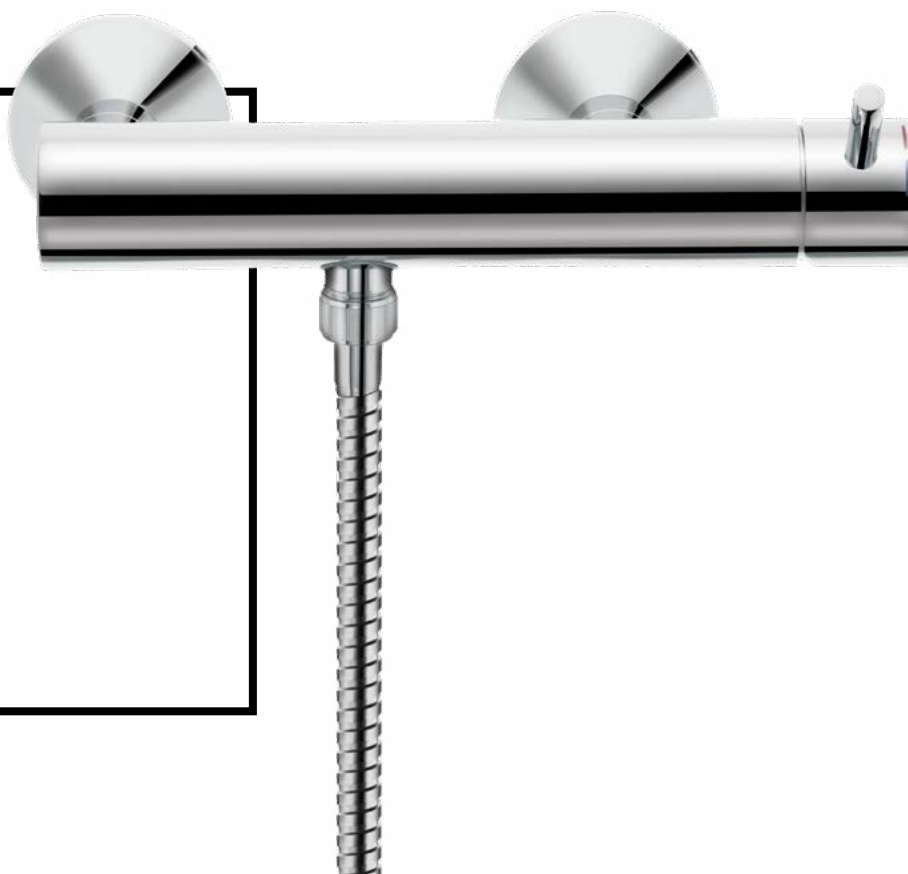

# FRESH

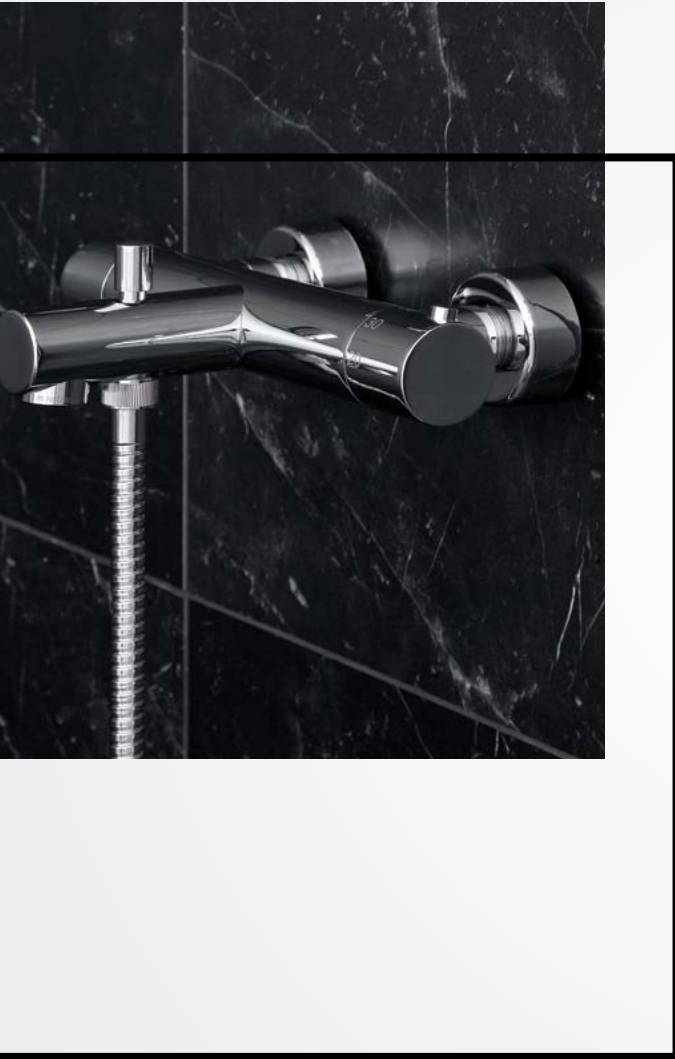

## THERMOSTATIC MIXERS

## THERMOSTAT ARMATUREN

/ Elegant round lines complete the exceptional usability of the thermostatic tapware of the Fresh line beautifully. The option of setting the desired temperature provides a special comfort and practicality, ensuring savings in consumed hot water and protection against burning, which is of particular importance for families with small children. The surface of the tapware does not get hot during its use and is, thus, perfectly safe to touch.

/ Elegante Rundungen sorgen für ein ansprechendes Design bei den Thermostatarmaturen aus der Fresh-Kollektion. Die Einstellung der Wunschttemperatur ist komfortabel und praktisch zugleich. Sie ermöglicht es, warmes Wasser zu sparen und schützt vor Verbrennungen, was für Familien mit Kindern sehr wichtig ist. Die Armaturenoberfläche erhitzt sich nicht und ist somit auch absolut berührungssicher.



## Fresh termo f30

Thermostatic bath mixer  
Thermostat-Wannenarmatur



00339



00336



## Fresh termo f40

Thermostatic Shower mixer  
Thermostat-Duscharmatur



00440



00437



# FRESH IR

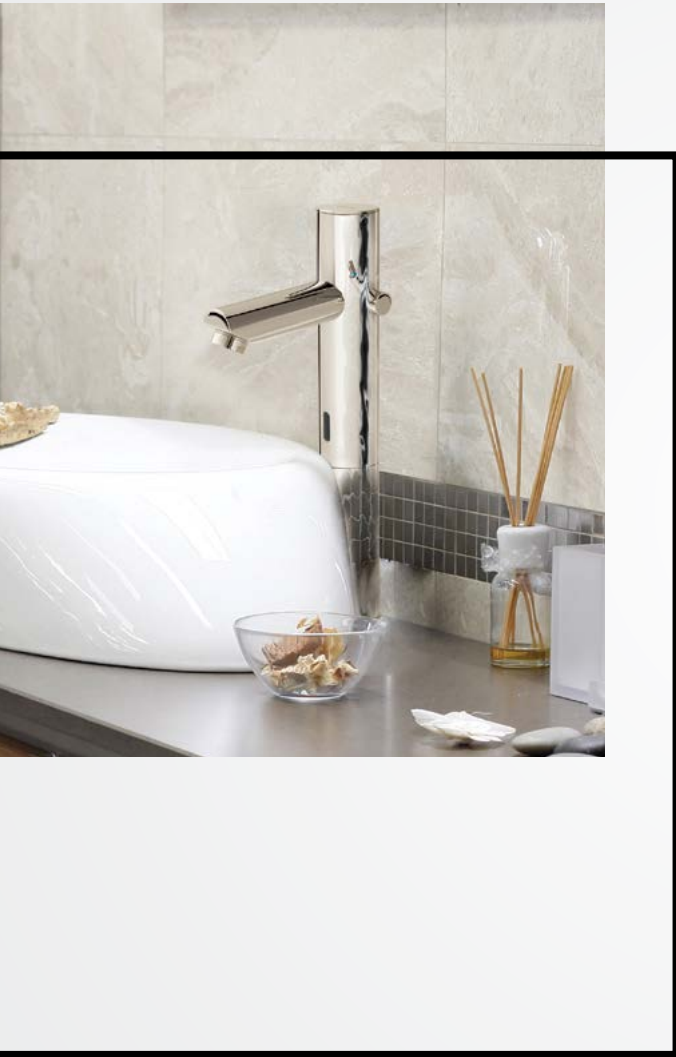

## SENSOR MIXERS

## SENSOR- ARMATUREN

A well thought-out and elaborate design combined with top-notch functionality

/ In addition to advantages as to hygiene, the sensor tapware provides comfort and safety to its users in setting the temperature beforehand, as well as water consumption savings. Therefore, more and more people decide also to use sensor tapware at home. The Fresh line comprises mixing and non-mixing washbasin tapware of different forms in battery and network versions.

Durchdachtes und ansprechendes Design kombiniert mit Top-Funktionalität

/ Neben hygienischen Vorteilen bieten die FRESH-Line-Sensorarmaturen auch Komfort und Sicherheit bei der Temperatureinstellung und reduzieren den Wasserverbrauch. Daher entscheiden sich immer mehr Menschen für die Verwendung von senorgesteuerten Armaturen auch im privaten Bereich. Die FRESH-Kollektion bietet eine große Auswahl an formschönen Armaturen mit und ohne Mischbatterie - ein innovativer Akzent auch für Ihr zuhause.





## Fresh IR f11

Sensor basin mixer  
Sensor-Waschbeckenarmatur



09116



09117



09124



Note: 09124 is combined with 19806 (adapter) and 19807 (adapter connector). 6 fittings can be connected to 1 adapter (p. 60).

Anmerkung: 09124 wird mit 19806 (Adapter) und 19807 (Adapter-Anschluss) kombiniert. 6 Fittings können an 1 Adapter angeschlossen werden (S. 60).

## Fresh IR f12

Sensor basin mixer – high version  
Sensor-Waschbeckenarmatur – erhöhte Version



09120



09121



09125



Note: 09125 is combined with 19806 (adapter) and 19807 (adapter connector). 6 fittings can be connected to 1 adapter (p. 60).

Anmerkung: 09125 wird mit 19806 (Adapter) und 19807 (Adapter-Anschluss) kombiniert. 6 Fittings können an 1 Adapter angeschlossen werden (S. 60).

/ FRESH-IR for cold or premixed water, 9V battery or 230V mains power, programmable electronics.

/ FRESH-IR für kaltes oder vorgemischtes Wasser, 9V-Batterie oder 230V-Netzstrom, programmierbare Elektronik.



## Fresh IR mix f11

Sensor basin mixer  
Sensor-Waschbeckenarmatur



09118



09119



09126

Note: 09126 is combined with 19806 (adapter) and 19807 (adapter connector). 6 fittings can be connected to 1 adapter (p. 60).

Anmerkung: 09126 wird mit 19806 (Adapter) und 19807 (Adapter-Anschluss) kombiniert. 6 Fittings können an 1 Adapter angeschlossen werden (S. 60).



## Fresh IR mix f12

Sensor basin mixer – high version  
Sensor-Waschbeckenarmatur – erhöhte Version



09122



09123



09127

Note: 09126 is combined with 19806 (adapter) and 19807 (adapter connector). 6 fittings can be connected to 1 adapter (p. 60).

Anmerkung: 09126 wird mit 19806 (Adapter) und 19807 (Adapter-Anschluss) kombiniert. 6 Fittings können an 1 Adapter angeschlossen werden (S. 60).

/ FRESH-IR for cold or premixed water, 9V battery or 230V mains power, programmable electronics.

/ FRESH-IR für kaltes oder vorgemischtes Wasser, 9V -Batterie oder 230V-Netzstrom, programmierbare Elektronik.



## Fresh IR f61

Covering plate with sensor  
Abdeckplatte mit Sensor

12261



/ Cover plate with sensor, for products 09511 in 09512. ABS, white  
/ Abdeckplatte mit Sensor für Produkt 09511 und 09512. ABS, weiß

## Fresh IR f62

Covering plate with sensor  
Abdeckplatte mit Sensor

12263



/ Cover plate with sensor, for products 09511 in 09512. ABS, chrome mat  
/ Abdeckplatte mit Sensor für Produkt 09511 und 09512. ABS, chrom-matt

## Fresh IR f65

Urinal sensor flusher/battery version  
Urinal Sensorspüler / Batterieversion

9V

09510



## Fresh IR f60

Concealed urinal sensor flusher -  
Installation set  
Unterputz - Urinal Sensorspüler  
Einbauset

9V

09511

230V

09512

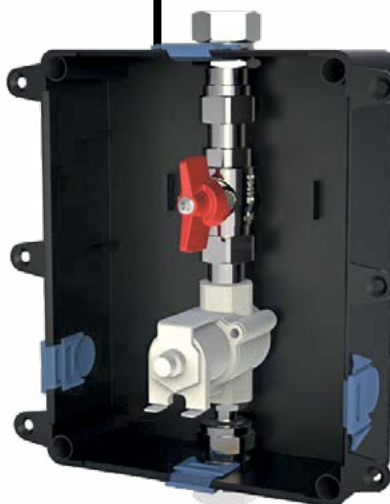

09511 Concealed, 1/2", 9 V  
without cover plate  
Unterputz, 1/2", 9 V ohne  
Abdeckplatte

09512 Concealed, 1/2", 230  
V without cover plate  
Unterputz, 1/2", 230 V ohne  
Abdeckplatte



## Elite IR e60

Flush-mounted electronic urinal flusher, wall-mounted set, cover plate with sensor  
Elektronische Toilettenspülung für die Unterputzmontage, Set für die Wandmontage, Abdeckplatte mit Sensor

**NEW**



09521

09522

# 12704

Premixing set  
Vormischungsset

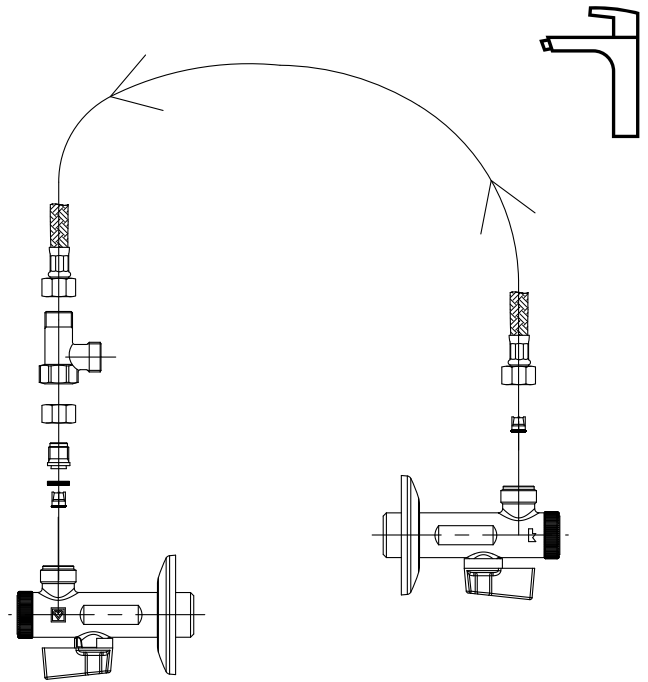

Note: for products: 09116, 09117, 09120, 09121, 09124, 09125

Anmerkung: für Produkte: 09116, 09117, 09120, 09121, 09124, 09125

# 19806

230/9V adapter for connecting to 6 fittings in total

Adapter 230/9V zum Anschluss von insgesamt bis zu 6 Armaturen

**NEW**



Note: the adapter is 36 x 32 x 21 mm

Anmerkung: der Adapter ist 36 x 32 x 21 mm

# 19807

Adapter connector 19806

Adapter-Anschluss 19806

**NEW**



Note: the length of the connector is 250 mm

Anmerkung: die Länge des Steckers beträgt 250 mm



# CLASSIC SERIES

BATHROOM  
BADEZIMMER



## Harmony h10

Basin mixer  
Waschbeckenarmatur



00093



00092



00094



00091



01095



01096



## Harmony h50

Bidet mixer  
Bidetarmatur



00594



00592



00591





## Harmony h30

Bath/shower mixer  
Wannen-/Duscharmatur



00395



00393



00394

## Harmony h40

Shower mixer  
Duscharmatur



00493



00491



00492



## Project m10

Basin mixer\*  
Waschbeckenarmatur\*



00026



00024



00025



00023

\* Also available: base for basin/bidet mixer, product no. 19228.

\* Auch erhältlich: Sockel für Waschtischbatterie, Artikelnummer 19228.



## Project m50

Bidet mixer\*  
Bidetarmatur\*



00518



00516



00515

\* Also available: base for basin/bidet mixer, product no. 19228.

\* Auch erhältlich: Sockel für Waschtischbatterie, Artikelnummer 19228.



## Project m30

Bath/shower mixer  
Wannen-/Duscharmatur



00326



00325

## Project m40

Shower mixer  
Duscharmatur



00427



00425



## Simpaty s10

Basin mixer  
Waschbeckenarmatur



00084



00082



00083



00081



01081



01082

## Simpaty s50

Bidet mixer  
Bidetarmatur



00584



00582



00581



## Simpaty s01

Washbasin mixer – medical  
Waschtischmischer – medizinisch



00037



/ All sanitary mixers of the Simpaty family can be equipped with a medical lever.

/ Alle Sanitärarmaturen der Simpaty-Familie können mit einem medizinischen Hebel ausgestattet werden.

## Simpaty s32

Mixer for sink and bath  
Mischer für Waschbecken  
und Badewanne



00387



00383



00386



## Simpaty s31

Bath/shower mixer  
Wannen-/Duscharmatur



00388



00389



## Simpaty s30

Bath/shower mixer  
Wannen-/Duscharmatur



00380



00381



00384



## Simpaty s40

Bath/shower mixer  
Wannen-/Duscharmatur



00480



00481



00482



## Simpaty s45

Bath/shower mixer  
Wannen-/Duscharmatur



01381



/ This model is fitted for high pressure boilers. Shower head is included.  
/ Dieses Modell ist für Hochdruckboiler geeignet; der Brausekopf ist im Lieferumfang enthalten.

### STIL sanitary mixers

An interesting interlacement of classical forms and vintage, retro lines is associated with beautiful details in chrome or gold. Giving your home a touch of tradition and homeliness

### STIL Sanitärarmaturen

Die klassische Form mit Retro-Elementen wird hervorgehoben durch wunderschöne verchromte und vergoldete Details.



## Stil z11\*

Basin mixer  
Waschbeckenarmatur



07066



07072



07061



## Stil z12\*

Basin mixer  
Waschbeckenarmatur



07067



07077



07062

\* version chrome - gold

\* Ausführung Chrom - Gold





## Stil z30\*

Bath/shower mixer  
Wannen-/Duscharmatur



07357



## Stil z40\*

Shower mixer  
Duscharmatur



07465



07462



## Stil z50\*

Bidet mixer  
Bidetarmatur



07558



07554



\* version chrome - gold

\* Ausführung Chrom - Gold



# Stil z11

Basin mixer  
Waschbeckenarmatur



07068



07073



07063



# Stil z12

Basin mixer  
Waschbeckenarmatur



07078



07079



07064



## Stil z30

Bath/shower mixer  
Wannen-/Duscharmatur



07358



## Stil z40

Shower mixer  
Duscharmatur



07466



07464



## Stil z50

Bidet mixer  
Bidetarmatur



07559



07555





## Val v11

Basin mixer  
Waschbeckenarmatur



07074



07060



07053



07055



## Val v12

Washbasin mixer "J"-outflow  
Waschtischmischer "J"-Auslauf



07065



07076



07057



07059



## Val v50

Bidet mixer  
Bidetarmatur



07550



07557



07553



## Val v40

Shower mixer  
Duscharmatur



07454



07452



## Val v31

Mixer for sink and bath  
Armatur für Waschbecken und  
Badewanne



07356



## Val v30

Bath/shower mixer  
Wannen-/Duscharmatur



07355





## Classic c01

Basin mixer  
Waschbeckenarmatur



10052

Note: Available in combination with Stil handle (with ceramic upper part).  
Anmerkung: Auch in Kombination mit Stil Griff erhältlich (Keramik-Oberteil).



10072



## Classic c02

Basin mixer  
Waschbeckenarmatur



10151

Note: Available in combination with Stil handle (with ceramic upper part).  
Anmerkung: Auch in Kombination mit Stil Griff erhältlich (Keramik-Oberteil).



10171



## Classic c06

Basin mixer  
Waschbeckenarmatur



10352

Note: Available in combination with Stil handle (with ceramic upper part).  
Anmerkung: Auch in Kombination mit Stil Griff erhältlich (Keramik-Oberteil).



10372

## Classic c07

Basin mixer  
Waschbeckenarmatur



10354



10374

Note: Available in combination with Stil handle (with ceramic upper part).  
Anmerkung: Auch in Kombination mit Stil Griff erhältlich (Keramik-Oberteil).

## Classic c13

Basin mixer  
Waschbeckenarmatur



10652



10672

Note: Available in combination with Stil handle (with ceramic upper part).  
Anmerkung: Auch in Kombination mit Stil Griff erhältlich (Keramik-Oberteil).

## Classic c15

Basin mixer  
Waschbeckenarmatur



10551



10571

Note: Available in combination with Stil handle (with ceramic upper part).  
Anmerkung: Auch in Kombination mit Stil Griff erhältlich (Keramik-Oberteil).

## Classic c04

Basin mixer  
Waschbeckenarmatur



10251



## Classic c05

Basin mixer  
Waschbeckenarmatur



10351

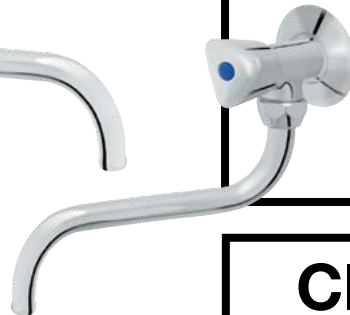

## Classic c14

Basin mixer  
Waschbeckenarmatur



10651



## Classic c08

Basin mixer  
Waschbeckenarmatur



10355



## Classic c03

Water tap - valve  
Wasserhahn - Ventil



10152



## Classic c09

Water tap - valve  
Wasserhahn - Ventil



10356



Note: for washing machine or dishwasher 3/4"

Anmerkung: für Waschmaschine oder  
Geschirrspüler 3/4"



## Classic c43

Water tap - hand shower  
Wasserhahn - Handbrause



10451





## Classic c11

Basin mixer  
Waschbeckenarmatur



05056



05055

## Classic c50

Bidet mixer  
Bidetarmatur



05554



05557



05553

## Classic c31

Mixer for sink and bath  
Armatur für Waschbecken und  
Badewanne



05355



## Classic c30

Bath/shower mixer  
Wannen-/Duscharmatur



05351



## Classic c40

Shower mixer  
Duscharmatur



05452



05451



## Classic c44

Water tap - shower fixed  
Wasserhahn - Stehbrause



10452



## Classic c42

Bath/shower mixer  
Wannen-/Duscharmatur



05455

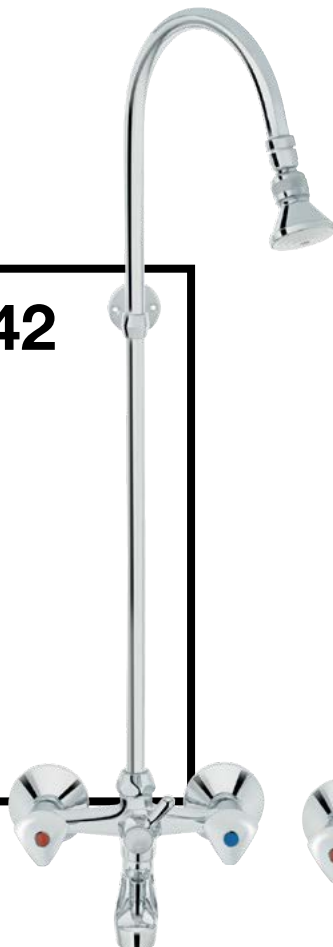

## Classic c41

Shower mixer  
Duscharmatur



05454



# PUSH



## Push p65

Self-closing tap for urinal  
Selbstschließende -Urinal Armatur



00031

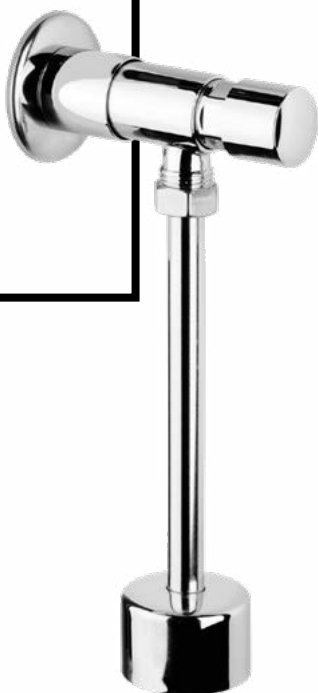

## Push p10

Self-closing tap for basin  
Selbstschließende Waschtischarmatur



00029



PUSH  
MIXERS

PUSH  
ARMATUREN

## Push mix p10

Mixing Self-closing tap for basin  
Selbstschließende Waschtischarmatur



00030



## Push p15

Self-closing tap for basin  
Selbstschließende Waschtischarmatur



00033



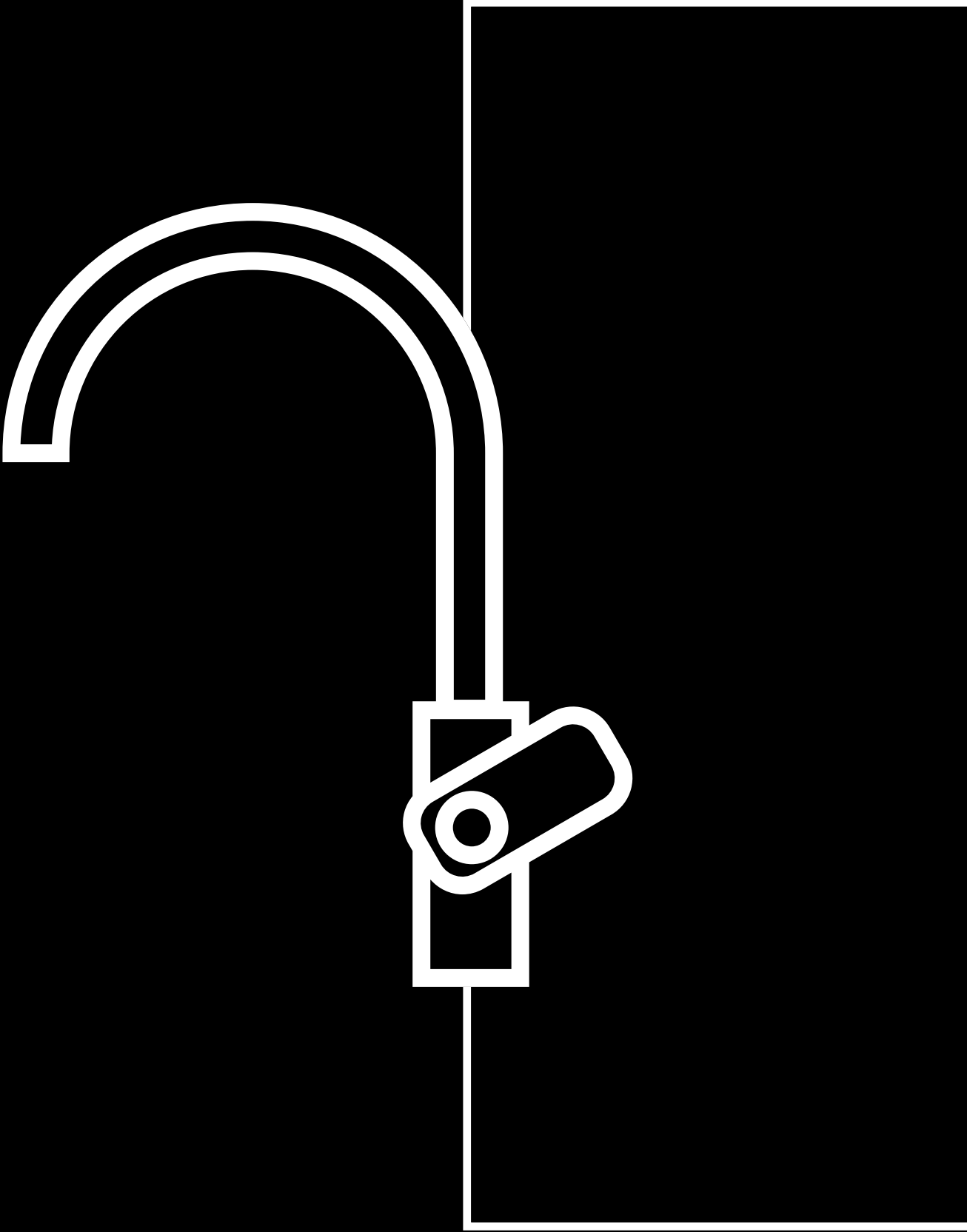

KITCHEN  
KÜCHE



# DESIGN SERIES

KITCHEN

KÜCHE

# DESIGN SERIES



/ The Elite line fits into the interior with modern equipment excellently, and the tapware, as the central element of your kitchen, will thus attract many approving glances. The synergy of straight and rounded lines emphasises the elegance of clearly defined straight shapes or softer curves of kitchen units and completes the visual image of your kitchen in a selected manner. A simple and economical selection for a top-notch effect.





/ Die Elite-Kollektion ist durch die Verbindung von zeitgenössischem Design mit Funktionalität ein absoluter Blickfang auch in Ihrer Küche. Mit eleganter Schlichtheit unterstreichen Elite-Armaturen die klar definierten Formen modernen Kücheninterieurs. Und das zu einem sehr attraktiven Preis-/Leistungsverhältnis.



## Elite e20B

Sanitary kitchen mixer  
Küchenarmatur



00101B

01101B

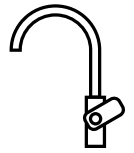

## Elite side e20Ni

Sanitary kitchen mixer\*  
Küchenarmatur\*



00103Ni 01107Ni

\* brushed nickel  
\* nickel gebürstet



## Elite e20

Sanitary kitchen mixer  
Küchenarmatur



00101



00102



01101

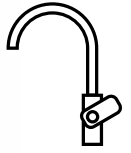

## Elite side e20

Sanitary kitchen mixer  
Küchenarmatur



00103



01107



## Elite e21

Sanitary kitchen mixer  
Küchenarmatur



00104



00105



01102

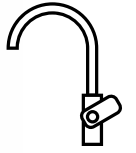

## Elite side e21

Sanitary kitchen mixer  
Küchenarmatur



00106

01108



## Elite e22

Sanitary kitchen mixer with pullout spray  
Küchenarmatur mit Auszugsbrause



00111



00112



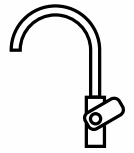

## Elite side e22

Sanitary kitchen mixer with pullout spray  
Küchenarmatur mit Auszugsbrause



00113



# Elite e23

Sanitary kitchen mixer with pullout spray  
Küchenarmatur mit Auszugsbrause



00114



00115

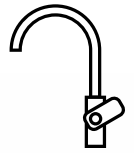

## Elite side e23

Sanitary kitchen mixer with pullout spray  
Küchenarmatur mit Auszugsbrause



00116



## Elite e24

Sanitary kitchen mixer with flexible spout  
Küchenarmatur mit flexiblem Auslauf



00120



01120

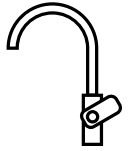

## Elite side e24

Sanitary kitchen mixer with flexible spout  
Küchenarmatur mit flexiblem Auslauf



00121



01121

# DESIGN SERIES



/ Infinity kitchen mixers with their modern lines and simplicity of use can be easily placed into any contemporary kitchen. The combination of straight and curved lines appears elegant, but yet contemporary. Sophisticated design united with deliberate solutions and range of possibilities in different spouts offering the optimal choice for reliability and the freedom of use in your kitchen. Our assortment of INFINITY kitchen mixers includes the models with three types of fully movable spouts and side handles that can be used on the left or right side.



/ Infinity Küchenarmaturen passen mit ihren modernen, eleganten Linienführung in jede moderne Küche. Durchdachte Lösungen, funktionale Bedienelemente und mehrere Modellvarianten sind perfekt auf die Anforderungen im Küchenbereich abgestimmt. Links- und rechtshändige Montage für individuellen Bedienkomfort möglich.

# K E I N E I N



## Infinity i20

Sanitary kitchen mixer  
Küchenarmatur



00170



00169



01169



## Infinity i21

Sanitary kitchen mixer  
Küchenarmatur



00172



00171



01171



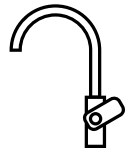

## Infinity i70

Sanitary wall mixer  
Wandarmatur

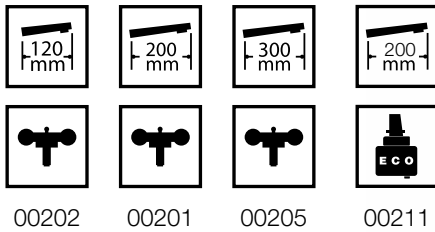

## Infinity i71

Sanitary kitchen mixer - medical  
Küchenarmatur - medizinisch



Note: length of handle 200 mm  
Anmerkung: länge des Griffs 200 mm





# Infinity i22

Sanitary kitchen mixer  
Küchenarmatur



00174

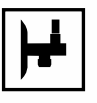

00173



01173

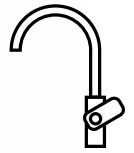

## Infinity i23

Sanitary kitchen mixer  
Küchenarmatur



00176



00175



01175

# DESIGN SERIES



/ Elaborate design and the play of softer shapes in the Fresh line for kitchens is combined with a range of practical solutions. The tapware, with a flexible outlet in case your kitchen sink is placed by the window, is certainly something special. Thus, the window can be opened and shut freely. The thermostatic kitchen tapware enabling hot water savings and protection against burning also stands out in the Fresh line.



# FRESH LINE

/ Aufwändiges Design und das Spiel weicher Formen: die Fresh-Line kombiniert moderne Optik mit innovativer Funktionalität. Sie möchten von Ihrer Spüle aus direkt aus dem Fenster blicken? Kein Problem mit den kippbaren Unterfenster-Armaturen, wodurch Ihr Küchenfenster problemlos geöffnet bzw. geschlossen werden kann. Innovativ ist auch die Armatur mit Thermostatfunktion zur Reduktion des Warmwasserverbrauchs und mit Verbrühschutz. Geniale Ideen auf den Punkt gebracht.



**Fresh f22**

Sanitary kitchen mixer – flexible spout  
Küchenarmatur - flexibler Auslauf

|   |   |   |
|---|---|---|
|  |  |  |
| 00136   | 00135   | 01138   |



Flexibility: forwards 100°, backwards 10°  
Flexibilität: vorwärts 100°, rückwärts 10°



## Fresh f23

Sanitary kitchen mixer – flexible spout  
Küchenarmatur - flexibler Auslauf



00147



00145



01146

Flexibility: forwards 100°,  
backwards 10°

Flexibilität: vorwärts 100°,  
rückwärts 10°



## Fresh f24

Sanitary kitchen mixer – flexible spout  
Küchenarmatur - flexibler Auslauf



00146



00144



01145

Flexibility: forwards 100°, backwards 10°

Flexibilität: vorwärts 100°, rückwärts 10°

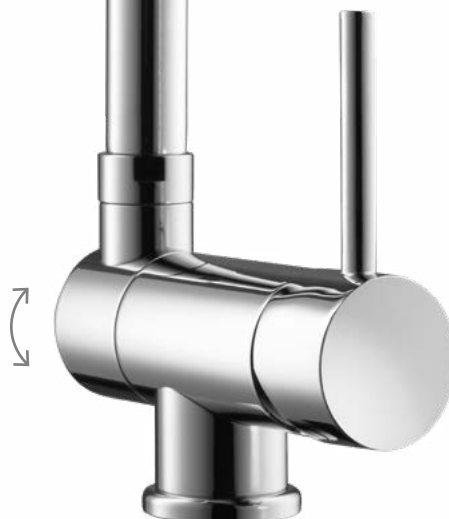



## Fresh f21

Sanitary kitchen mixer  
Küchenarmatur



00133



00134



01137



01140



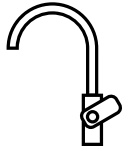

## Fresh f25

Sanitary kitchen mixer  
Küchenarmatur



00131



00132



01143



01144



## Fresh f26

Sanitary kitchen mixer  
Küchenarmatur



00129



00130



01141



01142





## Fresh f20

Sanitary kitchen mixer with pullout spray  
Küchenarmatur mit Auszugsbrause



00138



00137

/ Uniquely designed shape of mixer that enables to direct the water jet randomly in the harder reachable parts of dishes. Ideal for deeper kitchen sinks. Easy opening.

/ Die einzigartige Ausführung der Armatur variiert den Wasserstrahl nach dem Zufallsprinzip, sodass auch schwer zugängliche Bereiche des Geschirrs sauber gespült werden. Ideal für tiefere Küchenspülen geeignet. Einfaches Öffnen.





# CLASSIC SERIES

KITCHEN  
KÜCHE



# Project m20

Sanitary wall kitchen mixer  
Wandarmatur für die Küche



00185



00184



01185

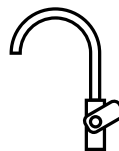

# Harmony h70

Sanitary kitchen mixer  
Küchenarmatur



00292

00291



# Simpaty s20

Sanitary kitchen mixer  
Küchenarmatur



00186



00182



01182



01184



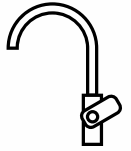

## Simpaty s22

Sanitary kitchen mixer  
Küchenarmatur



00188



00189



01189



01188



## Simpaty s23

Sanitary kitchen mixer  
Küchenarmatur



00190



00193



01187



01186





## Simpaty s21

Sanitary kitchen mixer  
Küchenarmatur



00183



00181



01181



01183



00180



## Simpaty s75

Sanitary wall kitchen mixer  
Wandarmatur für die Küche



01281

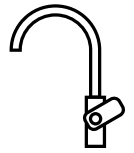

## Simpaty s70

Sanitary wall kitchen mixer  
Wandarmatur für die Küche



120  
mm



200  
mm



00282



00281



131

## Simpaty s71

Basin mixer – for hospitals  
Waschbeckenarmatur –  
für Krankenhäuser



200  
mm



00237



Note: length of handle 200 mm

Anmerkung: länge des Griffs 200 mm



## Stil z70\*

Sanitary kitchen mixer  
Küchenarmatur



07260



## Stil z71\*

Sanitary kitchen mixer  
Küchenarmatur



07261



## Stil z72\*

Sanitary kitchen mixer  
Küchenarmatur



07262

\* version chrome - gold

\* Ausführung Chrom - Gold

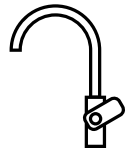

## Stil z20\*

Sanitary kitchen mixer  
Küchenarmatur



07162



07156



08149



## Stil z21\*

Sanitary kitchen mixer  
Küchenarmatur



07165



07157



08163



## Stil z75\*

Sanitary wall kitchen mixer  
Wandarmatur für die Küche



08255



\* version chrome - gold  
\* Ausführung Chrom - Gold



## Stil z70

Sanitary kitchen mixer  
Küchenarmatur



07263



## Stil z71

Sanitary kitchen mixer  
Küchenarmatur



07264



## Stil z72

Sanitary kitchen mixer  
Küchenarmatur



07265

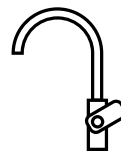

## Stil z20

Sanitary kitchen mixer  
Küchenarmatur



07169



07158



08150



## Stil z21

Sanitary kitchen mixer  
Küchenarmatur



07163



07159



08161



01164



## Stil z75

Sanitary wall kitchen mixer  
Wandarmatur für die Küche



08256

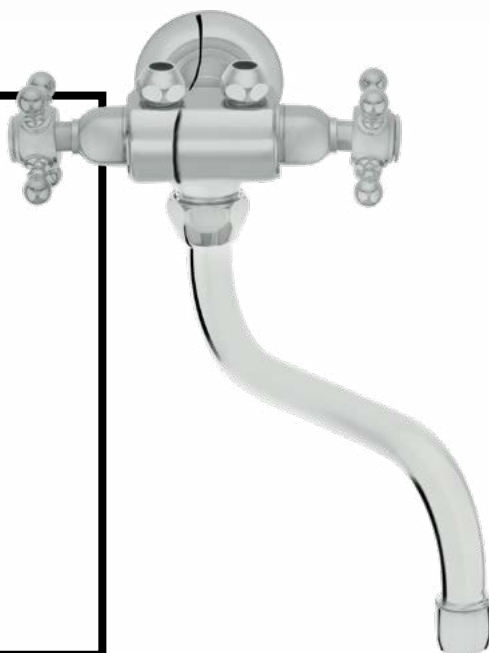



## Val v20

Kitchen mixers "HU"-outflow  
Küchenarmatur "HU"-Auslauf



07164



07153



08148



08153



## Val v21

Kitchen mixers "J"-outflow  
Küchenarmatur "J"-Auslauf



07161



07155



08166



08164



## Val v75

Sanitary wall kitchen mixer  
Wandarmatur für die Küche



08253



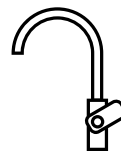

## Val v70

Sanitary kitchen mixer  
Küchenarmatur



07257



## Val v71

Sanitary kitchen mixer  
Küchenarmatur



07258



## Val v72

Sanitary kitchen mixer  
Küchenarmatur



07259



## Classic c20

Sanitary kitchen mixer  
Küchenarmatur



05154



06156



06158

## Classic c71

Sanitary kitchen mixer  
Küchenarmatur



05252

## Classic c72

Sanitary kitchen mixer  
Küchenarmatur



05253

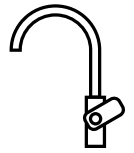

## Classic c70

Sanitary kitchen mixer  
Küchenarmatur



05251



## Classic c75

Sanitary kitchen mixer  
Küchenarmatur



06251



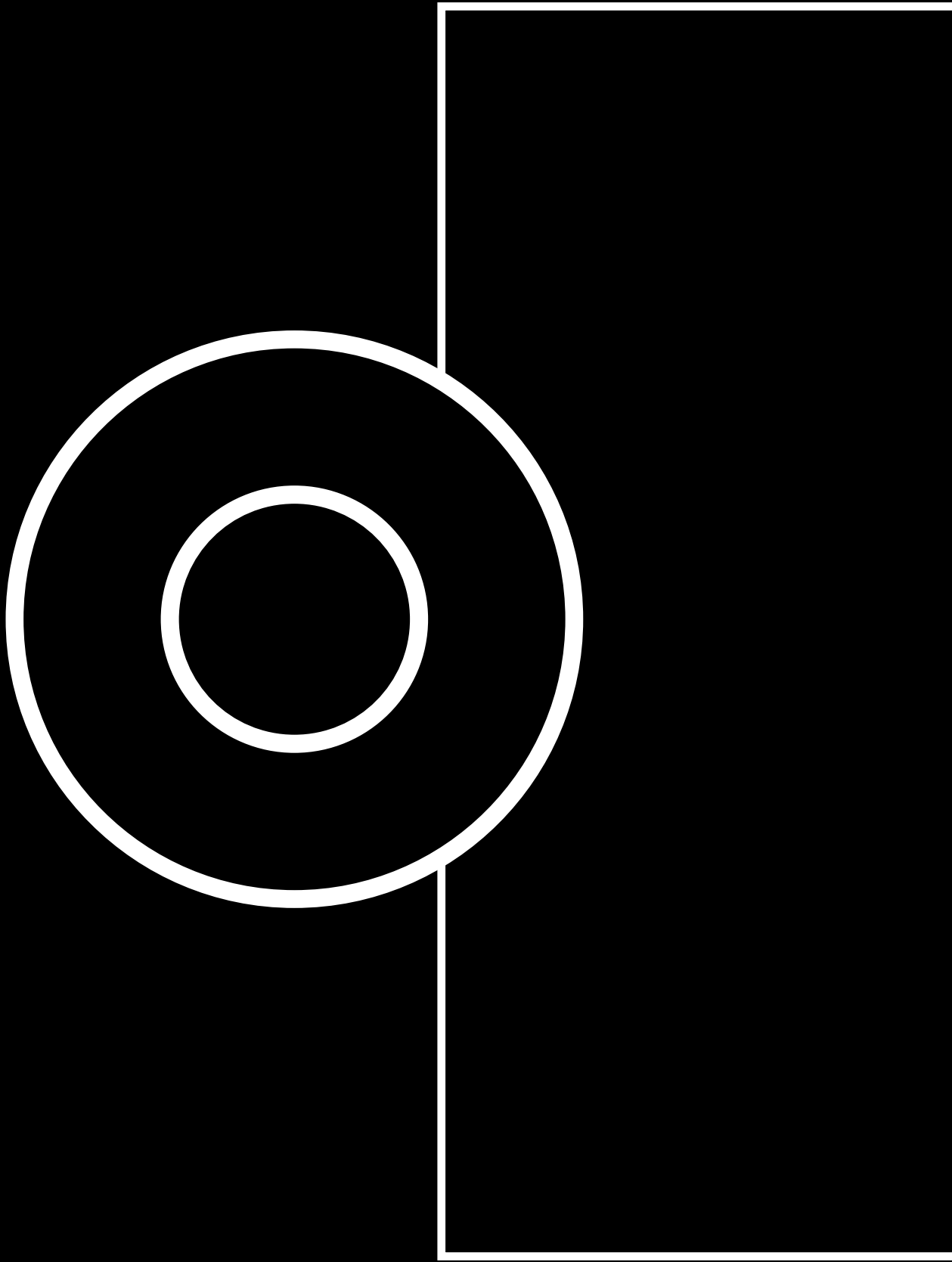

CONCEALED  
MIXERS  
UNTERPUTZ-  
ARMATUREN

# CONCEALED MIXERS UNTERPUTZ- ARMATUREN





## Elite e90

Rosette and handle for concealed shower mixer

Sichtteil für Unterputz-Einhebelmischer



12246

Note: compatible with concealed shower mixer 00367

Anmerkung: kompatibel mit Unterputz-Duscharmatur 00367



## Elite e91

Rosette and handle for concealed mixer for the tub or 2 showers

Sichtteil für Unterputz-Einhebelmischer für die Wanne oder 2 Duschen



12247

Note: compatible with concealed bath/shower mixer or mixer for two showers 00368

Anmerkung: kompatibel mit Unterputz-Wannen-/Duscharmatur oder für zwei Duschen 00368



## Elite e90B

Rosette and handle for concealed shower mixer

Sichtteil für Unterputz-Einhebelmischer



12246B

Note: compatible with concealed shower mixer 00367B

Anmerkung: kompatibel mit Unterputz-Duscharmatur 00367B



## Elite e91B

Rosette and handle for concealed mixer for the tub or 2 showers

Sichtteil für Unterputz-Einhebelmischer für die Wanne oder 2 Duschen



12247B

Note: compatible with concealed bath/shower mixer or mixer for two showers 00368B

Anmerkung: kompatibel mit Unterputz-Wannen-/Duscharmatur oder für zwei Duschen 00368B





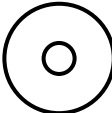

## SQ q90

Set of rosette, handle and concealed shower mixer\*

Set bestehend aus Sichtteil mit Einhebelmischer und Unterputz-Duscharmatur \*



00361



## SQ q91

Set of rosette, handle and concealed mixer for the tub or 2 showers\*

Set bestehend aus Sichtteil mit Einhebelmischer und Unterputz-Duscharmatur für Wanne oder 2 Duschen\*



00362



## SQ q90B

Set of rosette, handle and concealed shower mixer \*

Set bestehend aus Sichtteil mit Einhebelmischer und Unterputz-Duscharmatur \*



00361B



## SQ q91B

Set of rosette, handle and concealed mixer for the tub or 2 showers\*

Set bestehend aus Sichtteil mit Einhebelmischer und Unterputz-Duscharmatur für Wanne oder 2 Duschen\*



00362B



Note: \*set

Anmerkung: \*set

## Fresh f90

Rosette and handle for concealed shower mixer  
Sichtteil für Unterputz-Einhebelmischer



12259



## Fresh f91

Rosette and handle for concealed mixer for the tub or 2 showers  
Sichtteil für Unterputz-Einhebelmischer für die Wanne oder 2 Duschen



12260

Note: compatible with concealed bath/shower mixer or mixer for two showers 00368

Anmerkung: kompatibel mit Unterputz-Wannen-/Duscharmatur oder für zwei Duschen 00368

## Project m90

Rosette and handle for concealed shower mixer  
Sichtteil für Unterputz-Einhebelmischer



12251



## Project m91

Rosette and handle for concealed mixer for the tub or 2 showers  
Sichtteil für Unterputz-Einhebelmischer für die Wanne oder 2 Duschen



12252

Note: compatible with concealed bath/shower mixer or mixer for two showers 00368

Anmerkung: kompatibel mit Unterputz-Wannen-/Duscharmatur oder für zwei Duschen 00368

## Infinity i90

Rosette and handle for concealed shower mixer  
Sichtteil für Unterputz-Einhebelmischer



12249



## Infinity i91

Rosette and handle for concealed mixer for the tub or 2 showers  
Sichtteil für Unterputz-Einhebelmischer für die Wanne oder 2 Duschen



12250

Note: compatible with concealed bath/shower mixer or mixer for two showers 00368

Anmerkung: kompatibel mit Unterputz-Wannen-/Duscharmatur oder für zwei Duschen 00368

Note: compatible with concealed shower mixer 00367

Anmerkung: kompatibel mit Unterputz-Duscharmatur 00367

Note: compatible with concealed shower mixer 00367

Anmerkung: kompatibel mit Unterputz-Duscharmatur 00367

Note: compatible with concealed shower mixer 00367

Anmerkung: kompatibel mit Unterputz-Duscharmatur 00367

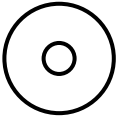

## Box b90

Concealed shower mixer  
Unterputz-Duscharmatur



00367



Note: entrance 2 x 1/2", exit 1 x 1/2",  
fitted casing only, for ø35 cartridge

Anmerkung: Eingang 2 x 1/2", Ausgang  
1 x 1/2", nur Einbaugehäuse, für ø35  
Kartusche

## Box b91

Concealed bath/shower mixer or mixer for  
two showers  
Unterputz-Wannen-/Duscharmatur oder für  
zwei Duschen



00368



Note: entrance 2 x 1/2", exit 1 x 1/2",  
fitted casing only, for ø35 cartridge

Anmerkung: Eingang 2 x  
1/2", Ausgang 1 x 1/2", nur  
Einbaugehäuse, für ø35 Kartusche

## Box b90B

Concealed shower mixer  
Unterputz-Duscharmatur



00367B



Note: entrance 2 x 1/2", exit 1 x 1/2",  
fitted casing only, for ø35 cartridge

Anmerkung: Eingang 2 x  
1/2", Ausgang 1 x 1/2", nur  
Einbaugehäuse, für ø35

## Box b91B

Concealed bath/shower  
mixer or mixer for two showers  
Unterputz-Wannen-/Duscharmatur oder für  
zwei Duschen



00368B

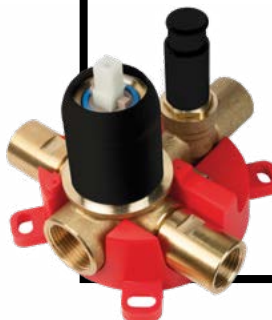

Note: entrance 2 x 1/2", exit 1 x  
1/2", fitted casing only, for ø35  
cartridge

Anmerkung: Eingang 2 x  
1/2", Ausgang 1 x 1/2", nur  
Einbaugehäuse, für ø35

# Fresh termo f91

Concealed thermostatic basin mixer  
 Unterputz-thermostatisch-  
 Waschtischbatterie

**NEW**



00399



Note: 19175 – extension  
 option  
 Anmerkung: 19175 -  
 Verlängerungsoption

# Infinity i92

Concealed part, rosette and handle set  
 Unterputzteil, Rosette und Bediengriff



00365



# 12703 12703B

Extension 25 mm for mixer  
 Verlängerung 25 mm für Armatur

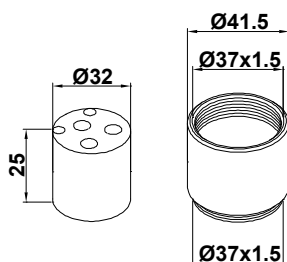

Note: 12703B for product 00367B and 00368B, 12703 for  
 product 00367 and 00368

Anmerkung: 12703B für Produkt 00367B und 00368B, 12703 für  
 Produkt 00367 und 00368

# 12701 12701B

Extension 25 mm for mixer  
 Verlängerung 25 mm für Armatur

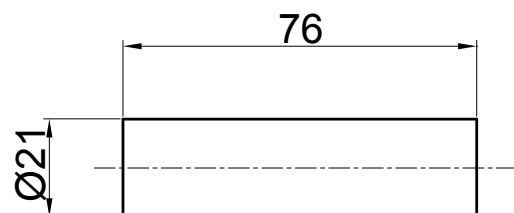

Note: 12701B for product 00368B and 12701 for product  
 00368

Anmerkung: 12701B für Produkt 00368B und 12701 für  
 Produkt 00368

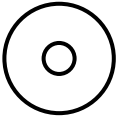

## Lino I90

Rosette and handle for concealed shower mixer

Sichtteil für Unterputz-Einhebelmischer

**NEW**



12269



Note: compatible with concealed shower mixer 00367  
Anmerkung: kompatibel mit Unterputz-Duscharmatur 00367

## Lino I91

Rosette and handle for concealed mixer for the tub or 2 showers

Sichtteil für Unterputz-Einhebelmischer für die Wanne oder 2 Duschen

**NEW**



12268



Note: compatible with concealed shower mixer 00368  
Anmerkung: kompatibel mit Unterputz-Duscharmatur 00368

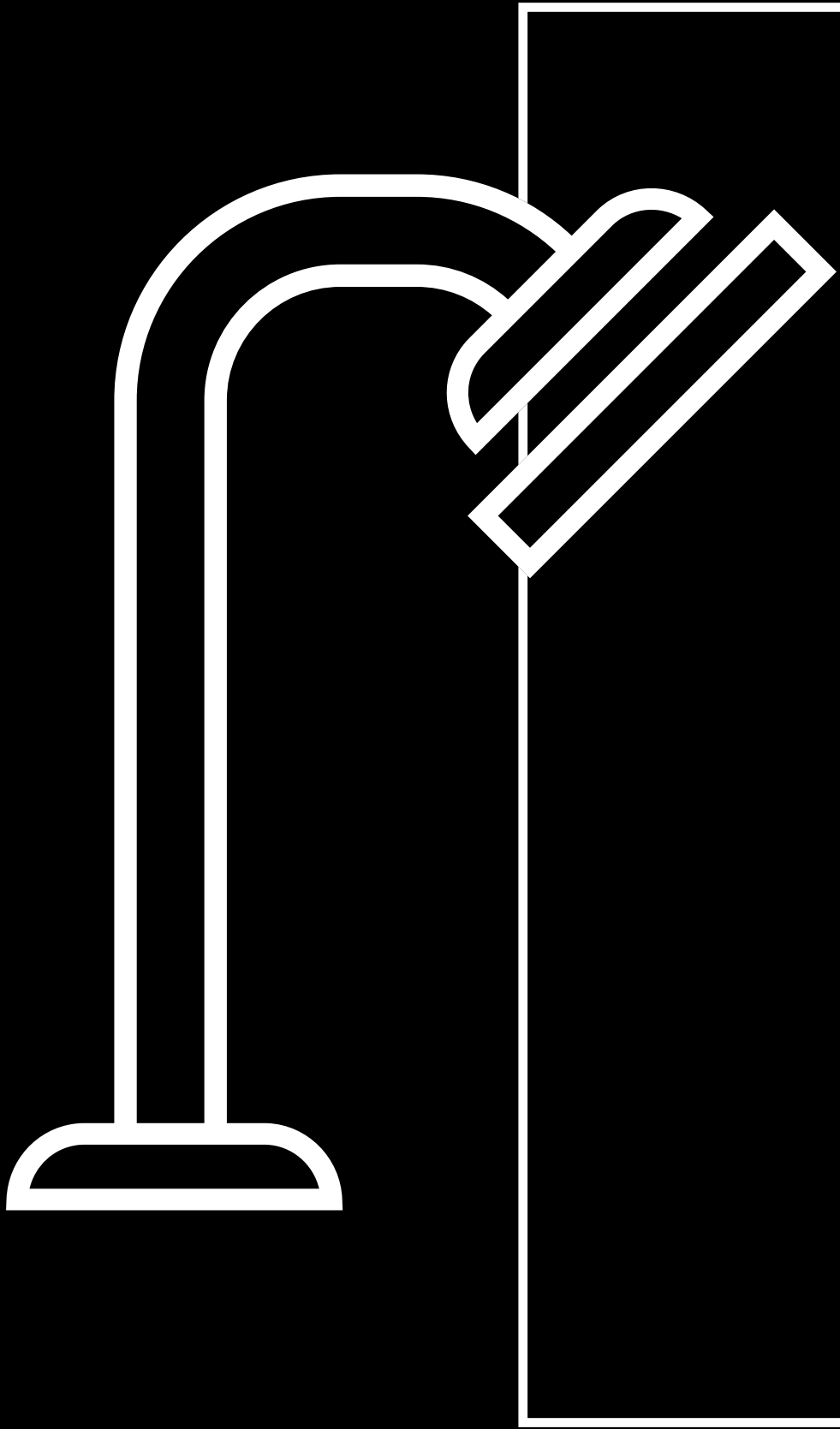

SHOWERS  
DUSCHEN

# SHOWERS DUSCHEN

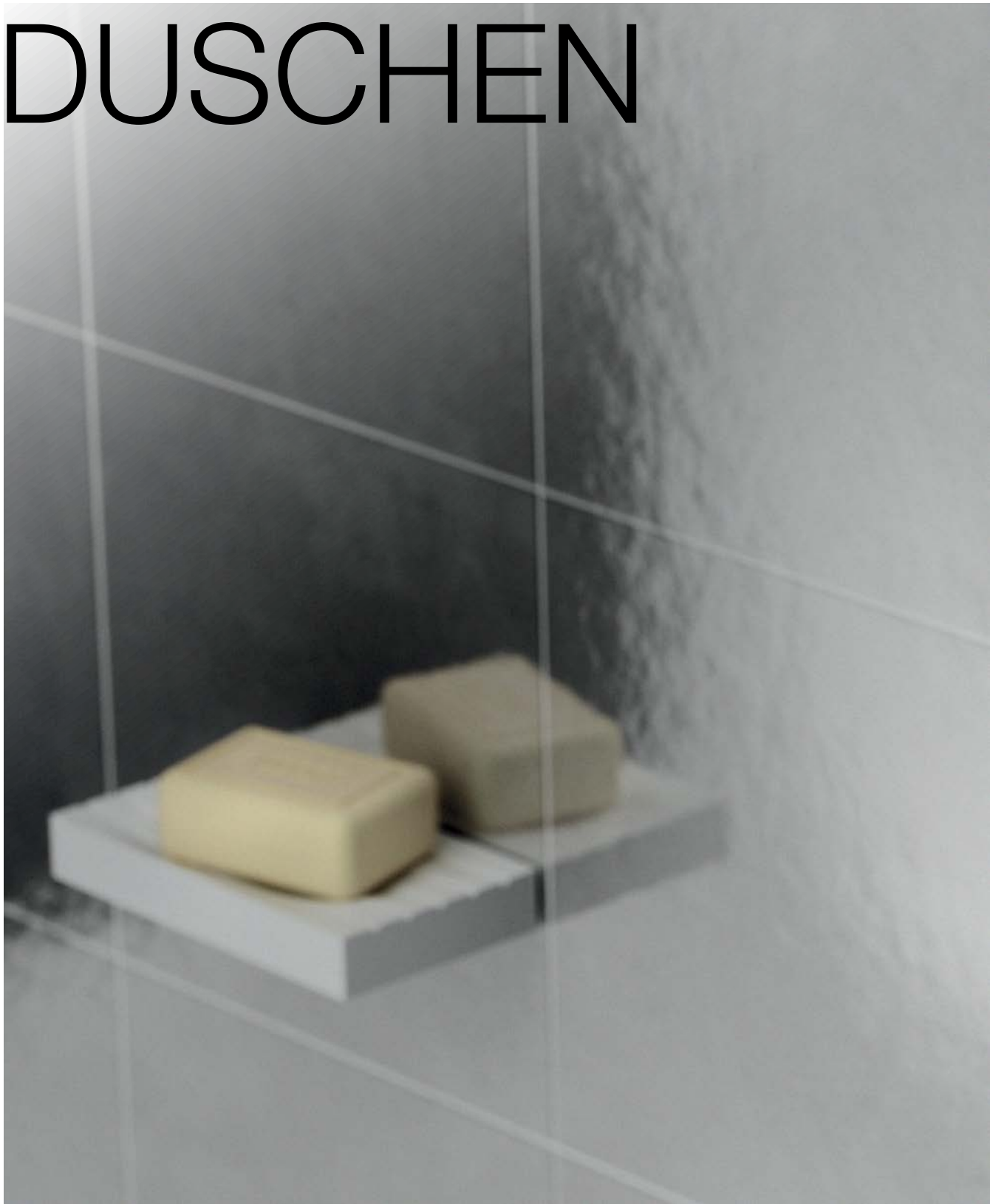





# HEAD SHOWER KOPFBRAUSE



**a200B**

Head shower  
Kopfbrause

**NEW**



12112B

Note: 200 x 200 mm, ABS  
Anmerkung: 200 x 200 mm, ABS



**a200**

Head shower  
Kopfbrause



12112

Note: 200 x 200 mm, ABS  
Anmerkung: 200 x 200 mm, ABS

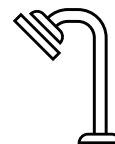

## a201B

Head shower  
Kopfbrause

**NEW**



12114B

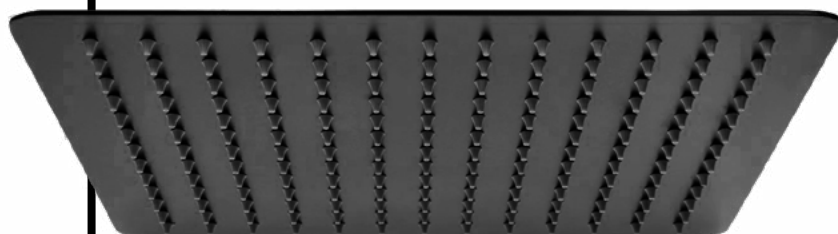

Note: 300 x 300 mm, INOX

Anmerkung: 300 x 300 mm, INOX

155

## a206

Head shower  
Kopfbrause



12109



Note: 300 x 300 mm, Brass

Anmerkung: 300 x 300 mm, Messing



## a204

Head shower  
Kopfbrause



12108

Note: 250 x 250 mm, ABS  
Anmerkung: 250 x 250 mm, ABS



## a205

Head shower - chrome  
Kopfbrause - chrom



12110

Note: 250 x 250 mm, ABS  
Anmerkung: 250 x 250 mm, ABS

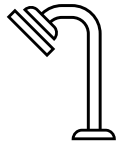

## a202

Head shower  
Kopfbrause



12104



Note: Ø 200 mm, Medenina  
Anmerkung: Ø 200 mm, Messing

## a202B

Head shower  
Kopfbrause

**NEW**



12113B



Note: Ø 200 mm, ABS  
Anmerkung: Ø 200 mm, ABS



## a207

Wall shower  
Wandbrause



12103

Note: Ø 227 mm, ABS  
Anmerkung: Ø 227 mm, ABS



## a207\*

Wall shower - white  
Wandbrause - weiß



12107

Note: Ø 227 mm, ABS  
Anmerkung: Ø 227 mm, ABS

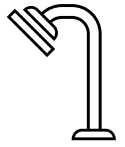

## a203

Wall shower  
Wandbrause



12106



Note: 260 x 200 mm, ABS

Anmerkung: 260 x 200 mm, ABS

## a209

Wall shower 1/2"  
Wandbrause 1/2"

12102



Note: Ø 85 mm

Anmerkung: Ø 85 mm

## a208

Wall shower 1/2"  
Wandbrause 1/2"

12101



Note: Ø 76 x 85 mm

Anmerkung: Ø 76 x 85 mm

# SHOWER HEADS BRAUSEKÖPFE



Note: 3 sprays

Anmerkung: 3-fach verstellbarer Wasserstrahl

Note: 3 sprays

Anmerkung: 3-fach verstellbarer Wasserstrahl

\* Shower hose not included!

\* Duschschauch ist separat zu bestellen!



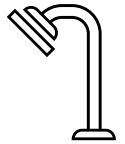

\* Shower hose not included!

\* Duschschauch ist separat zu bestellen!



# a306

Shower head, hose and wall holder  
Brausekopf, Brauseschlauch und Wandhalterung



12352

Note: shower set  
Anmerkung: Brauseset



# a307

Shower head\*  
Brausekopf\*



12043



# a308

Shower head, hose and wall holder  
Brausekopf, Brauseschlauch und Wandhalterung



12357

Note: shower set  
Anmerkung: Brauseset



# a309

Shower head\*  
Brausekopf\*



12047

\* Shower hose not included!  
\* Duschschlauch ist separat zu bestellen!

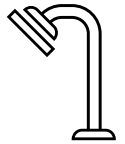

# a311

Shower head\*  
Brausekopf\*



12044



# a310

Shower head, hose  
and wall holder  
Brausekopf, Brauseschlauch  
und Wandhalterung



12351



Note: shower set / Anmerkung: Brauseset

# a313

Shower head\*  
Brausekopf\*



12042



# a312

Shower head, hose  
and wall holder  
Brausekopf, Brauseschlauch  
und Wandhalterung



12358



Note: shower set / Anmerkung: Brauseset

# a315

Shower head\*  
Brausekopf\*



12041



# a314

Shower head, hose  
and wall holder  
Brausekopf, Brauseschlauch  
und Wandhalterung



12354



Note: shower set / Anmerkung: Brauseset

# a316

Shower head - white  
Brausekopf - weiß



19088



\* Shower hose not included!

\* Duschschlauch ist separat zu bestellen.



SHOWERSYSTEM  
DUSCHSYSTEMS

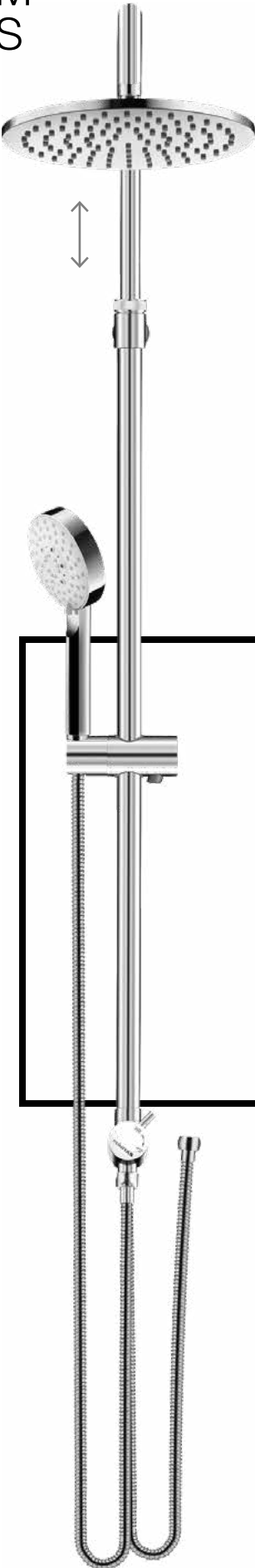
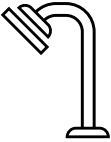

**a406**

Shower system  
Duschsystem



12551

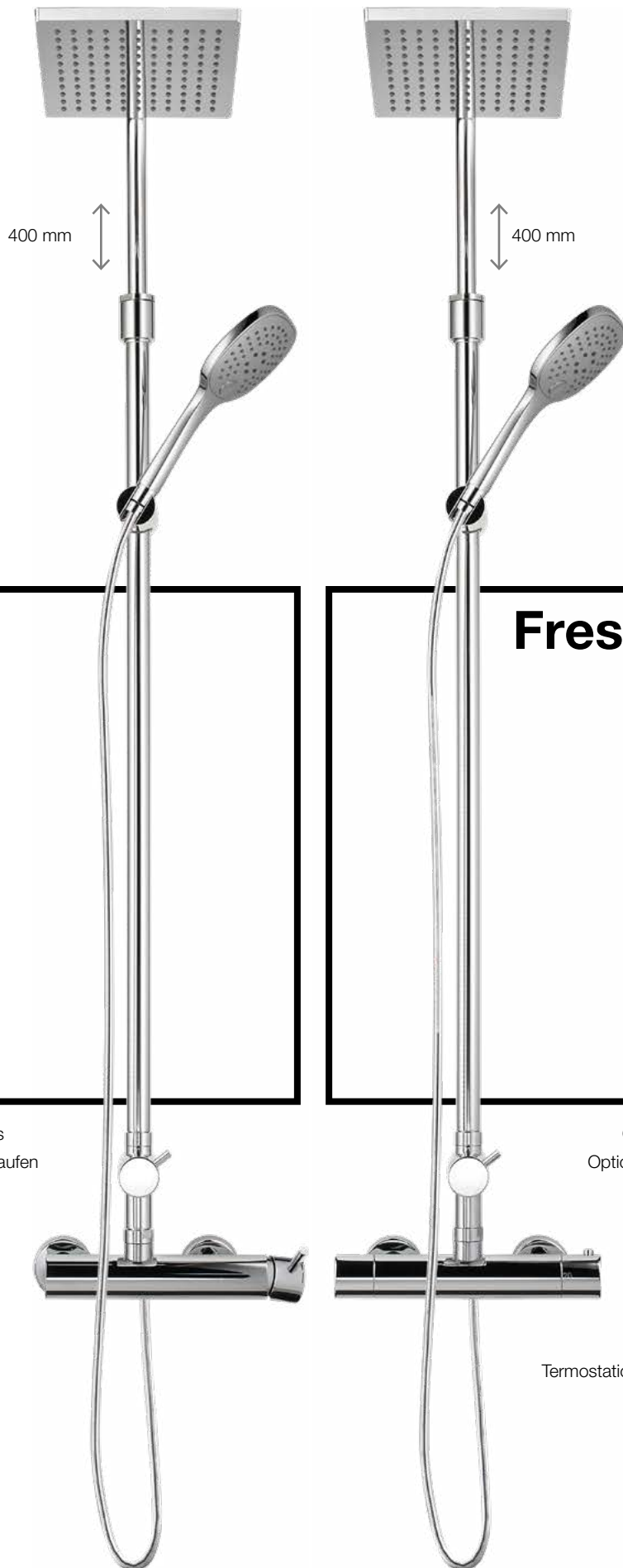

# Fresh f150

Shower system  
Duschsystem



00444

Option to buy only the fittings  
Option, nur die Armatur zu kaufen

# Fresh termo f150

Shower system  
Duschsystem



00443

Option to buy only the fittings  
Option, nur die Armatur zu kaufen

Termostatic

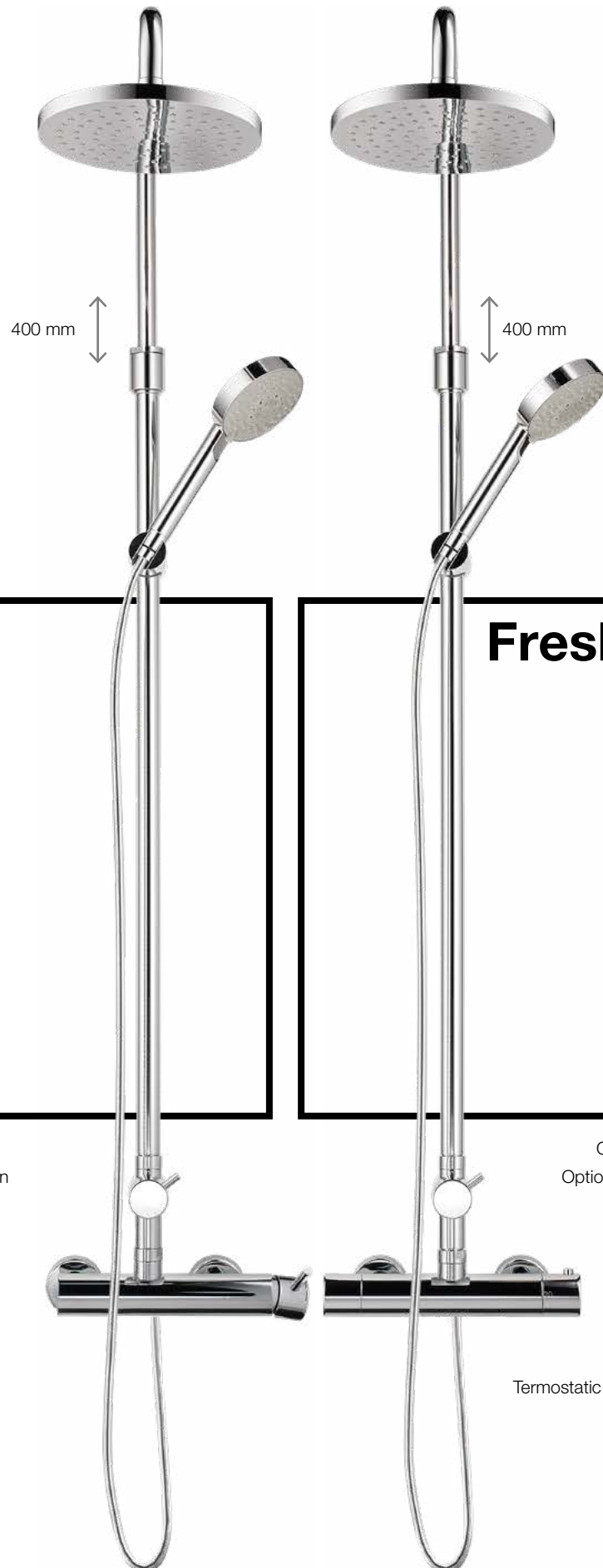
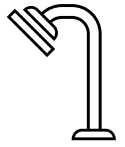

## Fresh f151

Shower system  
Duschsystem

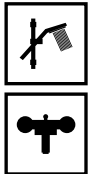

00442

Option to buy only the fittings  
Option, nur die Armatur zu kaufen

## Fresh termo f151

Shower system  
Duschsystem

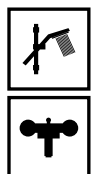

00441

Termostatic

# SHOWER SETS DUSCHSETS



## a400

Shower set with shower rail  
Duschset mit Brausestange

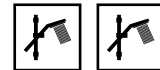

12455\* 12456

\* version chrome - gold

\* Ausführung Chrom - Gold

Note: Shower set, Brass

Anmerkung: Brauseset, messing



## a401

Shower set with shower rail  
(max 690mm)  
Duschset mit Brausestange  
(max 690mm)



12457

Note: Shower set, ABS

Anmerkung: Brauseset, ABS



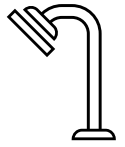

**a402**

Shower set with shower rail  
Duschset mit Brausestange



12463

Note: Shower rail Ø 24 mm, Brass  
Anmerkung: Brausestange Ø 24 mm, Messing



**a403**

Shower set with shower rail  
Duschset mit Brausestange



12452

Note: Shower rail Ø 18 mm, Brass  
Anmerkung: Brausestange Ø 18 mm, Messing



# a404

Shower set with shower rail  
Duschset mit Brausestange



12460

Note: Shower rail Ø 25 mm, ABS  
Anmerkung: Brausestange Ø 25 mm, ABS



# a405

Shower set with shower rail  
Duschset mit Brausestange



12461

Note: Shower rail Ø 24 mm, ABS  
Anmerkung: Brausestange Ø 24 mm, ABS

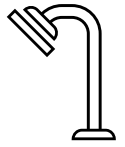

**a407**

Shower set with shower rail  
Duschset mit Brausestange



12464

Note: Shower rail, ABS  
Anmerkung: Brausestange, ABS



**a407B**

Shower set with shower rail  
Duschset mit Brausestange



12464B

Note: Shower rail, ABS  
Anmerkung: Brausestange, ABS

## Fresh f192

Concealed basin mixer with shut-off set  
Unterputz Waschtischbatterie mit shut-off set

SET

00359



## Fresh f192B

Concealed basin mixer with shut-off set  
Unterputz Waschtischbatterie mit shut-off set

SET

00359B



## a408

Shut-off set with wall - holder  
Ein-/Ausschaltung mit Wandhalterung



12361



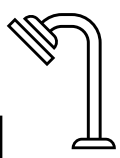

CONCEALED SHOWERS SYSTEMS  
 VERDECKTE CUSCHSYSTEME

**Fresh termo f191**

**NEW**

SET

00379



Head shower  
Kopfbrause



Wall shower holder 1/2"  
Wandbrausehalter 1/2"

Concealed thermostatic basin mixer  
Unterputz-thermostatisch-Waschtischbatterie



173

Set of rosette, handle and concealed mixer for the tub or 2 showers  
Set bestehend aus Sichtteil mit Einhebelmischer und Unterputz-Duscharmatur für Wanne oder 2 Duschen



Shower head  
Brausekopf



Wall shower connection 1/2"  
Wandbrauseanschluss 1/2"



Shower hose  
Brauseschlauch

# Elite e191B

**NEW**

SET

00377B



Head shower  
Kopfbrause

Wall shower holder 1/2"  
Wandbrausehalter 1/2"



Shower head  
Brausekopf



Set of rosette, handle and  
concealed mixer for the tub or  
2 showers

Set bestehend aus Sichtteil  
mit Einhebelmischer und  
Unterputz-Duscharmatur für  
Wanne oder 2 Duschen



Wall shower connection  
and shower holder 1/2"  
Wandbrauseanschluss  
und Brausehalter 1/2"



Shower hose  
Brauseschlauch

# Elite e191

SET

00377

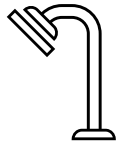

Head shower  
Kopfbrause



Concealed bath/shower mixer  
or mixer for two showers  
Unterputz-Wannen-/  
Duscharmatur oder für zwei  
Duschen

Wall shower holder 1/2"  
Wandbrausehalter 1/2"



Shower head  
Brausekopf



Rosette and handle for  
concealed mixer for the  
tub or 2 showers  
Sichtteil für Unterputz-  
Einhebelmischer für die  
Wanne oder 2 Duschen



Wall shower connection  
and shower holder 1/2"  
Wandbrauseanschluss  
und Brausehalter 1/2"



Shower hose  
Brauseschlauch

# SQ q191B

SET

00364B



Head shower  
Kopfbrause

Wall shower holder 1/2"  
Wandbrausehalter 1/2"

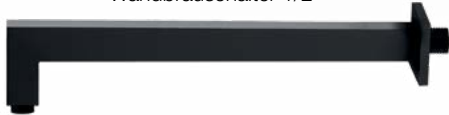

Shower hose  
Brauseschlauch

Wall shower connection  
and shower holder 1/2"  
Wandbrauseanschluss  
und Brausehalter 1/2"

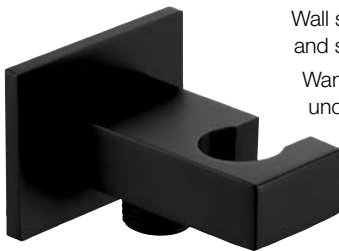

Set of rosette, handle and  
concealed mixer for the tub or  
2 showers

Set bestehend aus Sichtteil  
mit Einhebelmischer und  
Unterputz-Duscharmatur für  
Wanne oder 2 Duschen



Shower head  
Brausekopf



# SQ q191

SET

00364

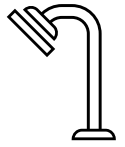

Head shower  
Kopfbrause

Wall shower connection 1/2"  
Wandbrauseanschluss 1/2"



Wall shower connection 1/2"  
Wandbrauseanschluss 1/2"



Shower hose  
Brauseschlauch



Set of rosette, handle and concealed  
mixer for the tub or 2 showers  
Set bestehend aus Sichtteil mit  
Einhebelmischer und Unterputz-  
Duscharmatur für Wanne oder 2  
Duschen



Shower head  
Brausekopf

# Infinity i191

SET

00371

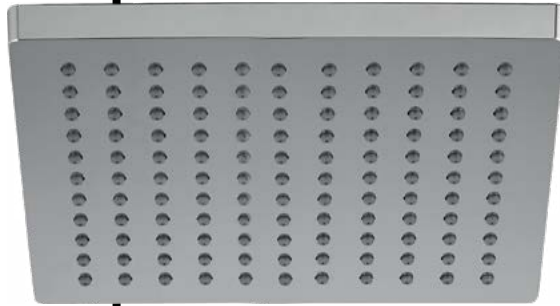

Head shower  
Kopfbrause



Set of rosette, handle and  
concealed mixer for the tub or  
2 showers

Set bestehend aus Sichtteil  
mit Einhebelmischer und  
Unterputz-Duscharmatur für  
Wanne oder 2 Duschen

Wall shower holder 1/2"  
Wandbrausehalter 1/2"



Shower hose  
Brauseschlauch

Set of rosette, handle and  
concealed mixer for the tub or  
2 showers

Set bestehend aus Sichtteil  
mit Einhebelmischer und  
Unterputz-Duscharmatur für  
Wanne oder 2 Duschen



Wall shower connection 1/2"  
Wandbrauseanschluss 1/2"



Wall shower holder  
Wandhalterung für Brause



Shower head  
Brausekopf



# Project m191

SET

00366

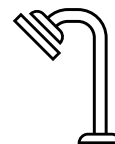

Head shower  
Kopfbrause



Set of rosette, handle and  
concealed mixer for the tub or  
2 showers

Set bestehend aus Sichtteil  
mit Einhebelmischer und  
Unterputz-Duscharmatur für  
Wanne oder 2 Duschen

Wall shower holder 1/2"  
Wandbrausehalter 1/2"



Set of rosette, handle and  
concealed mixer for the tub or  
2 showers

Set bestehend aus Sichtteil  
mit Einhebelmischer und  
Unterputz-Duscharmatur für  
Wanne oder 2 Duschen



Shower hose  
Brauseschlauch

Wall shower connection 1/2"  
Wandbrauseanschluss 1/2"



Wall shower holder  
Wandhalterung für Brause



Shower head  
Brausekopf



# Infinity i192

SET

00363



Concealed shower mixer  
Unterputz - Duscharmatur



Shower hose  
Brauseschlauch



Rosette and handle for  
concealed shower mixer  
Sichtteil für Unterputz -  
Einhebelmischer



Wall shower connection  
and shower holder 1/2"  
Wandbrauseanschluss 1/2"



Shower head  
Brausekopf

# SHOWER ACCESSORIES BRAUSEZUBEHÖR

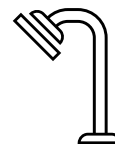

## a600

Shower hose  
Brauseschlauch

|           |            |            |
|-----------|------------|------------|
| 800<br>mm | 1500<br>mm | 2000<br>mm |
| 12003     | 12001      | 19038      |

## a601

Shower hose  
Brauseschlauch

|            |            |
|------------|------------|
| 1500<br>mm | 2000<br>mm |
|------------|------------|

12002 12004

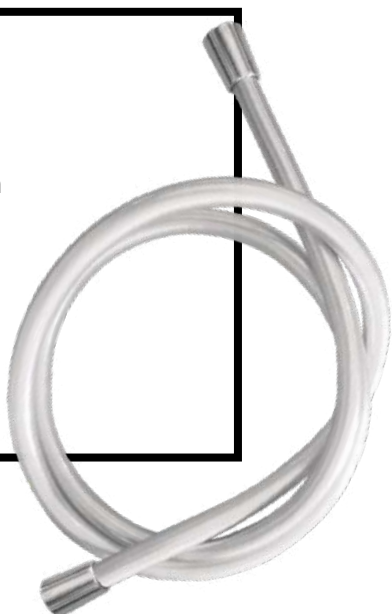

## a601B

Shower hose  
Brauseschlauch

|            |
|------------|
| 1500<br>mm |
|------------|

12005B



## a700

Wall shower holder 1/2"  
Wandbrausehalter 1/2"

12212



Note: 375 mm  
Anmerkung: 375 mm

## a700B

Wall shower holder 1/2"  
Wandbrausehalter 1/2"

12212B



Note: 375 mm  
Anmerkung: 375 mm

## a701

Wall shower holder 1/2"  
Wandbrausehalter 1/2"

12208



Note: 414 mm  
Anmerkung: 414 mm

## a702B

Wall shower holder 1/2"  
Wandbrausehalter 1/2"

**NEW**

12216B



Note: 375 mm  
Anmerkung: 375 mm

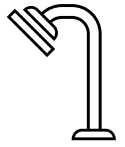

## a703B

Celing shower holder 1/2"  
Celing Brausehalter 1/2"

**NEW**

12220B

Note: 155 mm  
Anmerkung: 155 mm



## a704

Celing shower holder 1/2"  
Celing Brausehalter 1/2"

12209

Note: 150 mm  
Anmerkung: 150 mm

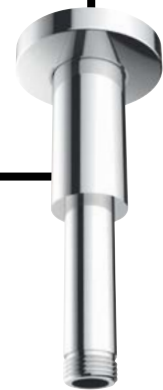

## a705

Wall shower holder 1/2"  
Wandbrausehalter 1/2"

12207

Note: 420 mm  
Anmerkung: 420 mm

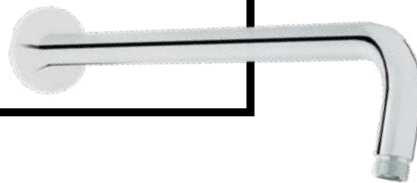

## a706

Wall shower holder 1/2"  
Wandbrausehalter 1/2"

12206

Note: 108 mm  
Anmerkung: 108 mm

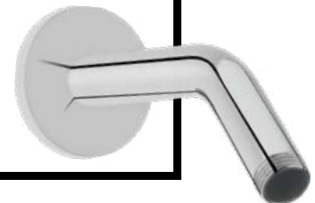

## a900

Bath spout 1/2"  
Wannenauslauf 1/2"

12201



Note: 150 mm  
Anmerkung: 150 mm

## a901

Bath spout 1/2"  
Wannenauslauf 1/2"

12202



Note: 180 mm  
Anmerkung: 180 mm

## a902

Bath spout 1/2"  
Wannenauslauf 1/2"

12211



Note: 180 mm  
Anmerkung: 180 mm

## a800

Wall shower connection  
and shower holder 1/2"  
Wandbrauseanschluss  
und Brausehalter 1/2"

12213



## a801

Wall shower connection  
and shower holder 1/2"  
Wandbrauseanschluss  
und Brausehalter 1/2"

12214



## a802

Wall shower holder  
Wandhalterung für Brause

12215





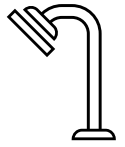

## a803B

Wall shower connection  
and shower holder 1/2"  
Wandbrauseanschluss  
und Brausehalter 1/2"

12218B



Note: Brass  
Anmerkung: Messing

## a804B

Wall shower connection 1/2"  
Wandbrauseanschluss 1/2"

12217B



Note: Brass  
Anmerkung: Messing

## a805B

Wall shower holder  
Wandhalterung für Brause

12219B



Note: ABS  
Anmerkung: ABS

## a800B

Wall shower connection  
and shower holder 1/2"  
Wandbrauseanschluss  
und Brausehalter 1/2"

12213B



Note: Brass  
Anmerkung: Messing

## a801B

Wall shower connection 1/2"  
Wandbrauseanschluss 1/2"

12214B



Note: Brass  
Anmerkung: Messing

## a802B

Wall shower holder  
Wandhalterung für Brause

12215B



Note: ABS  
Anmerkung: ABS

## a806

Wall shower connection 1/2"  
Wandbrauseanschluss 1/2"

12203



## a807

Wall shower connection 1/2"  
Wandbrauseanschluss 1/2"

12204



## a808

Wall shower connection 1/2"  
Wandbrauseanschluss 1/2"

12210



## a809

Wall shower holder  
Wandhalterung für Brause

12154

12155\*



\* version chrome - gold

\* Ausführung Chrom - Gold

## a810

Wall shower holder  
Wandhalterung für Brause

12151



## a811

Wall shower holder  
Wandhalterung für Brause

12152



## a812

Wall shower holder  
Wandhalterung für Brause

12153



**a500**

Shower rail  
Brausestange

12659



**a500B**

Shower rail  
Brausestange

12659B



**a501B**

Shower rail  
Brausestange

12660B



**a502**

Shower rail  
Brausestange

12651



**a503**

Shower rail  
Brausestange

12652



**a504**

Shower rail  
Brausestange

12653 12654\*

\* version chrome - gold  
\* Ausführung Chrom - Gold



**a505**

Shower rail  
Brausestange

12655



**a506**

Shower rail  
Brausestange

12657

max. 690 mm



**a507**

Shower rail  
Brausestange

19052



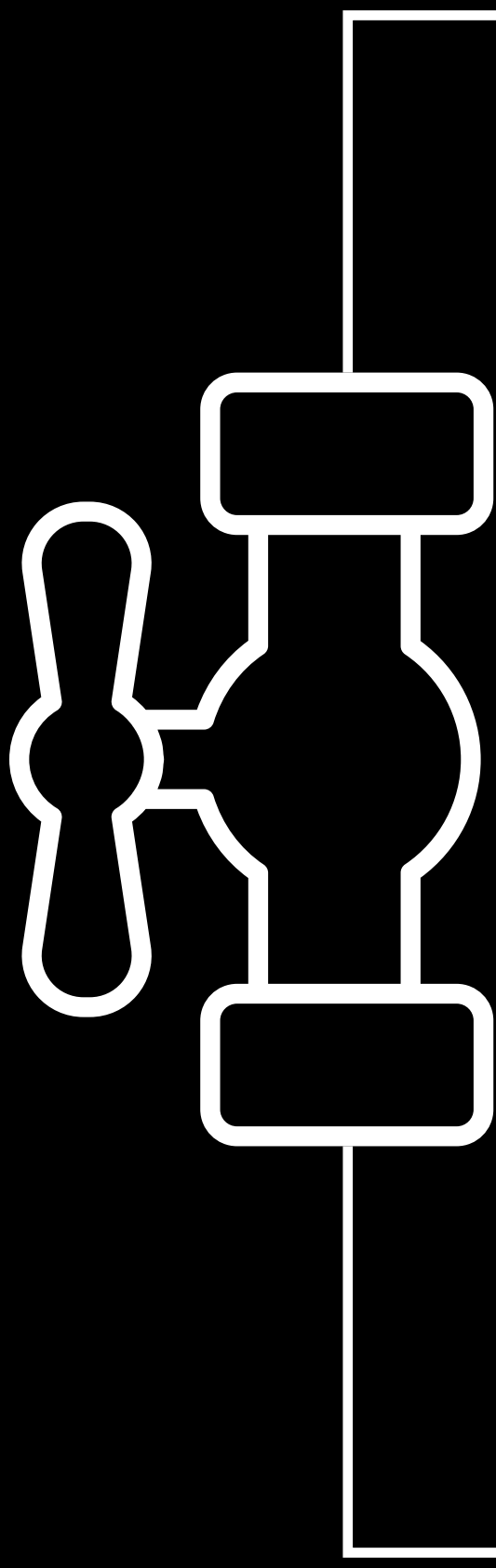

ACCESSORIES  
ZUBEHÖR

# SIPHONS

## SIPHON

### 16009B

Click clack Siphon for basin Black universal G1 1/4"

Click clack Universalsiphon für Waschbecken Black G1 1/4"



Note: Brass  
Anmerkung: Messing

### 16006

Click clack Siphon for basin with overflow G1 1/4"

Click clack Siphon mit Überlauf für Waschbecken G1 1/4"



Note: ABS  
Anmerkung: ABS

### 16007

Click clack Siphon for basin without overflow G1 1/4"

Click clack Siphon ohne Überlauf für Waschbecken G1 1/4"



Note: Brass  
Anmerkung: Messing

### 16008

Click clack Siphon for basin with overflow G1 1/4"

Click clack Siphon mit Überlauf für Waschbecken G1 1/4"



Note: Brass  
Anmerkung: Messing

### 16207B

Siphon for basin Black G 1 1/4"  
Siphon für Waschbecken Black G 1 1/4"



Note: extension can be bought 16208B  
Anmerkung: Verlängerung kann separat gekauft werden 16208B

### 16207

Siphon for basin G 1 1/4"  
Siphon für Waschbecken G 1 1/4"



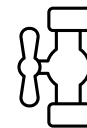

## 16206

Siphon for basin G 1 1/4"  
Siphon für Waschbecken G 1 1/4"



## 16306

Siphon set for basin G 1 1/4"  
Siphon-Set für Waschbecken  
G 1 1/4"



## 16202

Siphon set for bidet G 1 1/4"  
Siphon-Set für Bidet G 1 1/4"

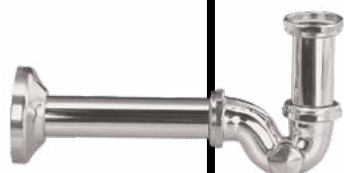

## 16302

Siphon set for basin G 1 1/4"  
Siphon-Set für Waschbecken  
G 1 1/4"



## 16303

Siphon set for bidet G 1 1/4"  
Siphon-Set für Bidet G 1 1/4"

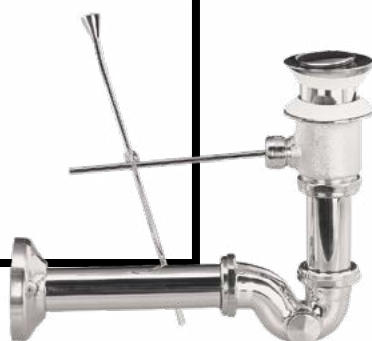

## 16305

Siphon set for basin  
G 1 1/4"  
Siphon-Set für  
Waschbecken G 1 1/4"



## 16005

Draining valve with siphon  
Ablaufgarnitur mit Siphon



## 16201

Siphon for basin G 1 1/4"  
Siphon für Waschbecken G 1 1/4"



## 16204

Siphon for urinal G 1 1/4"  
Siphon für Urinal G 1 1/4"



## 16301

Siphon set for basin G 1 1/4"  
Siphon-Set für Waschbecken  
G 1 1/4"



## 19253

Siphon plug  
Siphonstopfen





# VALVES VENTILE

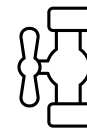

## 13112

Angle ball valve for urinal  
G 1/2" - 3/8"

Kugel Eckventil für Urinal  
G 1/2" - 3/8"



## 13113

Angle ball valve with filter  
G 1/2" - 3/8"

Kugel Eckventil mit Filter  
G 1/2" - 3/8"



## 19413

Diverter G 3/4"

Umschalter G 3/4"



## 19433

Diverter G 1/2" - 3/8"

Umschalter G 1/2" - 3/8"

**NEW**



## UH16004

Angle valve G 1/2" - 3/8"

Eckventil G 1/2" - 3/8"

**NEW**



**13001 1/2"**  
**13002 3/4"**

Safety valve 8 bars  
Sicherheitsventil 8 bar



**13003 1/2"**  
**13004 3/4"**

Safety valve 10 bars  
Sicherheitsventil 10 bar



**13301**

Opening valve G 1/2" - 1/2"  
Durchgangsventil G 1/2" - 1/2"



**13401**

Opening valve  
G 1/2" - 1/2"  
Durchgangsventil  
G 1/2" - 1/2"



**2 4215 61**

Closing valve G 1/2" - 3/4"  
Absperrventil G 1/2" - 3/4"



**2 77665 4**

Thermostatic mixing  
valve for drinking water  
G 3/4" - 3/4"  
Thermostatischer  
Mischventil für Trinkwasser  
G 3/4" - 3/4"



**16001**

Draining valve G 1 1/4"  
Ablaufventil G 1 1/4"



**16002**

Draining valve G 1 1/4"  
Ablaufventil G 1 1/4"



# ACCESSORIES ZUBEHÖR

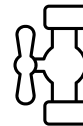

## 19001

Connection tubes 300/350 mm  
Verbindungsschläuche  
300/350 mm

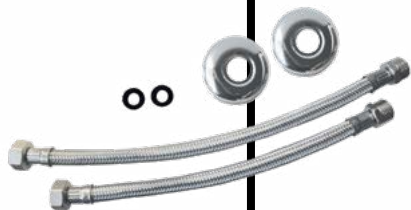

## 19021

Connection tubes  
Ø 10x440  
Verbindungsrohre  
Ø 10x440

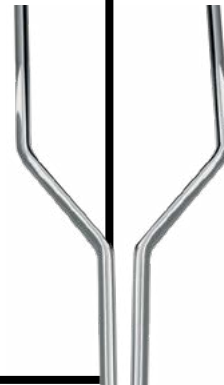

## 19023

Connection tubes  
Ø 10x422, nut 3/8"  
Verbindungsrohre  
Ø 10x422, Mutter 3/8"



## 19022

Connection tubes  
Ø 10x422, nut 1/2"  
Verbindungsrohre  
Ø 10x422, Mutter 1/2"



## 19110

Set for water conservation  
3-piece  
Set zur Wassereinsparung  
3-teilig



Note: Set includes 2 ECO aerators with water flow 6l/minute and water flow regulator with water flow of 9 l/minute. It could be used at all ranges HERZ.

Anmerkung: Das Set enthält 2 Eco-Perlatoeren mit einem Wasserdurchfluss von 6 l/min und einen Wasserdurchflussregler mit einem Wasserdurchfluss von 9 l/minute. Es kann in allen HERZ Programmen verwendet werden.

## 19209

Flat spout  
Flacher Auslauf (l = 200 mm)



## 19216

Flat spout  
Flacher Auslauf (l = 300 mm)



## 19132

Spout "S" Ø 13 x 200 mm  
Auslauf "S" Ø 13 x 200 mm



## 19133

Spout "S" Ø 13 x 300 mm  
Auslauf "S" Ø 13 x 300 mm



## 19145

Spout "S" Ø 18 x 250 mm  
Auslauf "S" Ø 18 x 250 mm

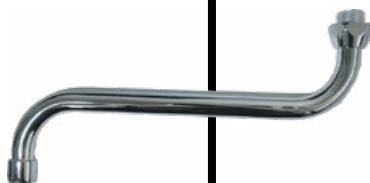

## 19204

Flat spout  
Flacher Auslauf (l = 120 mm)



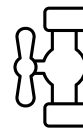

**19379**

Medical handle  
Medizinischer Handgriff



Note: length of handle 200 mm  
Anmerkung: länge des Griffs 200 mm

**19219**

Mat  
Sockel



Note: for products: Infinity 00004 and Elite 00088  
Anmerkung: für Produkte: Infinity 00004 und Elite 00088

**19504**

Reduction nut with seals  
Reduziermutter mit Dichtung



Note: G1/2 - G3/4  
Anmerkung: G1/2 - G3/4

**21001**

Rosette 3/4"  
Rosette 3/4"



**21002**

Rosette 3/4"  
Rosette 3/4"



**21161**

S-union with noise reduction  
Exzenter S mit Schallreduktion



# INDEX

|        |    |         |     |        |     |        |     |         |     |
|--------|----|---------|-----|--------|-----|--------|-----|---------|-----|
| 00001  | 48 | 00091   | 72  | 00201  | 113 | 00389  | 78  | 00592   | 72  |
| 00002  | 48 | 00092   | 72  | 00202  | 113 | 00393  | 73  | 00594   | 72  |
| 00003  | 48 | 00093   | 72  | 00205  | 113 | 00394  | 73  | 00595   | 31  |
| 00004  | 48 | 00094   | 72  | 00208  | 113 | 00395  | 73  | 00595B  | 27  |
| 00006  | 49 | 00095   | 43  | 00211  | 113 | 00396  | 44  | 00600   | 58  |
| 00011  | 48 | 00096   | 42  | 00237  | 131 | 00399  | 148 | 00601   | 58  |
| 00012  | 48 | 00101   | 100 | 00281  | 131 | 00401  | 51  | 01011   | 48  |
| 00013  | 48 | 00101B  | 98  | 00282  | 131 | 00402  | 51  | 01012   | 48  |
| 00014  | 48 | 00102   | 100 | 00291  | 127 | 00403  | 51  | 01035   | 59  |
| 00023  | 74 | 00103   | 101 | 00292  | 127 | 00411  | 51  | 01036   | 59  |
| 00024  | 74 | 00103Ni | 99  | 00301  | 50  | 00425  | 75  | 01081   | 76  |
| 00025  | 74 | 00104   | 102 | 00302  | 50  | 00427  | 75  | 01082   | 76  |
| 00026  | 74 | 00105   | 102 | 00303  | 50  | 00430  | 39  | 01095   | 72  |
| 00029  | 91 | 00106   | 103 | 00311  | 50  | 00430B | 37  | 01096   | 72  |
| 00030  | 91 | 00111   | 104 | 00325  | 75  | 00434  | 61  | 01101   | 100 |
| 00031  | 91 | 00112   | 104 | 00326  | 75  | 00435  | 61  | 01101B  | 98  |
| 00033  | 91 | 00113   | 105 | 00330  | 39  | 00437  | 63  | 01102   | 102 |
| 00034  | 60 | 00114   | 106 | 00330B | 37  | 00438  | 61  | 01107   | 101 |
| 00035  | 59 | 00115   | 106 | 00334  | 61  | 00440  | 63  | 01107Ni | 99  |
| 00037  | 77 | 00116   | 107 | 00335  | 61  | 00441  | 167 | 01108   | 103 |
| 00038  | 59 | 00120   | 108 | 00336  | 63  | 00442  | 167 | 01120   | 108 |
| 00039  | 59 | 00121   | 109 | 00337  | 61  | 00443  | 166 | 01121   | 109 |
| 00040  | 59 | 00129   | 121 | 00339  | 63  | 00444  | 166 | 01137   | 120 |
| 00042  | 58 | 00130   | 121 | 00359  | 172 | 00480  | 79  | 01138   | 118 |
| 00044  | 60 | 00131   | 121 | 00359B | 172 | 00481  | 79  | 01140   | 120 |
| 00045  | 60 | 00132   | 121 | 00360  | 32  | 00482  | 79  | 01141   | 121 |
| 00048  | 58 | 00133   | 120 | 00360B | 28  | 00485  | 23  | 01142   | 121 |
| 00049  | 58 | 00134   | 120 | 00361  | 145 | 00485B | 19  | 01143   | 121 |
| 00053  | 48 | 00135   | 118 | 00361B | 144 | 00486  | 23  | 01144   | 121 |
| 00057  | 31 | 00136   | 118 | 00362  | 145 | 00487  | 23  | 01145   | 119 |
| 00057B | 27 | 00137   | 122 | 00362B | 145 | 00490  | 45  | 01146   | 119 |
| 00058  | 30 | 00138   | 122 | 00363  | 180 | 00491  | 73  | 01164   | 135 |
| 00058B | 26 | 00144   | 119 | 00364  | 177 | 00492  | 73  | 01169   | 112 |
| 00059  | 52 | 00145   | 119 | 00364B | 176 | 00493  | 73  | 01171   | 112 |
| 00060  | 53 | 00146   | 119 | 00365  | 148 | 00494  | 33  | 01173   | 114 |
| 00069  | 54 | 00147   | 119 | 00366  | 179 | 00494B | 29  | 01175   | 115 |
| 00070  | 55 | 00169   | 112 | 00367  | 147 | 00501  | 49  | 01181   | 130 |
| 00077  | 38 | 00170   | 112 | 00367B | 147 | 00503  | 49  | 01182   | 128 |
| 00077B | 36 | 00171   | 112 | 00368  | 147 | 00515  | 74  | 01183   | 130 |
| 00078  | 43 | 00172   | 112 | 00368B | 147 | 00516  | 74  | 01184   | 128 |
| 00079  | 20 | 00173   | 114 | 00371  | 178 | 00518  | 74  | 01185   | 126 |
| 00080  | 22 | 00174   | 114 | 00373  | 23  | 00530  | 38  | 01186   | 129 |
| 00080B | 18 | 00175   | 115 | 00373B | 19  | 00530B | 36  | 01187   | 129 |
| 00081  | 76 | 00176   | 115 | 00374  | 23  | 00535  | 59  | 01188   | 129 |
| 00082  | 76 | 00180   | 130 | 00375  | 23  | 00536  | 59  | 01189   | 129 |
| 00083  | 76 | 00181   | 130 | 00377  | 175 | 00537  | 59  | 01281   | 130 |
| 00084  | 76 | 00182   | 128 | 00377B | 174 | 00538  | 59  | 01381   | 79  |
| 00085  | 21 | 00183   | 130 | 00379  | 173 | 00581  | 76  | 05055   | 89  |
| 00086  | 21 | 00184   | 126 | 00380  | 78  | 00582  | 76  | 05056   | 89  |
| 00087  | 21 | 00185   | 126 | 00381  | 78  | 00584  | 76  | 05154   | 138 |
| 00088  | 21 | 00186   | 128 | 00381  | 78  | 00586  | 21  | 05251   | 139 |
| 00088B | 17 | 00188   | 129 | 00383  | 77  | 00588  | 21  | 05252   | 138 |
| 00089  | 20 | 00189   | 129 | 00384  | 78  | 00588B | 17  | 05253   | 138 |
| 00089B | 16 | 00190   | 129 | 00386  | 77  | 00590  | 43  | 05351   | 89  |
| 00090  | 20 | 00193   | 129 | 00387  | 77  | 00591  | 72  | 05355   | 89  |
|        |    |         |     | 00388  | 78  |        |     |         |     |

|       |     |       |     |        |     |           |     |           |     |
|-------|-----|-------|-----|--------|-----|-----------|-----|-----------|-----|
| 05451 | 90  | 07452 | 85  | 10452  | 90  | 12213B    | 185 | 13002 3/4 | 194 |
| 05452 | 90  | 07454 | 85  | 10551  | 87  | 12214     | 184 | 13003 1/2 | 194 |
| 05454 | 90  | 07462 | 81  | 10571  | 87  | 12214B    | 185 | 13004 3/4 | 194 |
| 05455 | 90  | 07464 | 83  | 10651  | 88  | 12215     | 184 | 13112     | 193 |
| 05553 | 89  | 07465 | 81  | 10652  | 87  | 12215B    | 185 | 13113     | 193 |
| 05554 | 89  | 07466 | 83  | 10672  | 87  | 12216B    | 182 | 13301     | 194 |
| 05557 | 89  | 07550 | 84  | 12001  | 181 | 12217B    | 185 | 13401     | 194 |
| 06156 | 138 | 07553 | 84  | 12002  | 181 | 12218B    | 185 | 16001     | 196 |
| 06158 | 138 | 07554 | 81  | 12003  | 181 | 12219B    | 185 | 16002     | 196 |
| 06251 | 139 | 07555 | 83  | 12004  | 181 | 12220B    | 183 | 16005     | 192 |
| 07053 | 84  | 07557 | 84  | 12005B | 181 | 12246     | 144 | 16006     | 160 |
| 07055 | 84  | 07558 | 81  | 12040  | 160 | 12246B    | 144 | 16007     | 190 |
| 07057 | 84  | 07559 | 83  | 12040B | 160 | 12247     | 144 | 16008     | 190 |
| 07059 | 84  | 08148 | 136 | 12041  | 163 | 12247B    | 144 | 16009B    | 190 |
| 07060 | 84  | 08149 | 133 | 12042  | 163 | 12249     | 146 | 16201     | 192 |
| 07061 | 80  | 08150 | 135 | 12043  | 162 | 12250     | 146 | 16202     | 191 |
| 07062 | 80  | 08153 | 136 | 12044  | 163 | 12251     | 146 | 16204     | 192 |
| 07063 | 822 | 08161 | 135 | 12047  | 162 | 12252     | 146 | 16206     | 191 |
| 07064 | 82  | 08163 | 133 | 12050  | 161 | 12259     | 146 | 16207     | 190 |
| 07065 | 84  | 08164 | 136 | 12054  | 160 | 12260     | 146 | 16207B    | 190 |
| 07066 | 80  | 08166 | 136 | 12055  | 160 | 12261     | 67  | 16301     | 192 |
| 07067 | 80  | 08253 | 136 | 12057  | 161 | 12263     | 67  | 16302     | 191 |
| 07068 | 82  | 08255 | 133 | 12058  | 161 | 12268     | 149 | 16303     | 191 |
| 07072 | 80  | 08256 | 135 | 12058B | 161 | 12269     | 149 | 16305     | 191 |
| 07073 | 82  | 09116 | 65  | 12101  | 159 | 12351     | 163 | 16306     | 191 |
| 07074 | 84  | 09117 | 65  | 12102  | 159 | 12352     | 162 | 19001     | 195 |
| 07076 | 84  | 09118 | 66  | 12103  | 158 | 12354     | 163 | 19021     | 195 |
| 07077 | 80  | 09119 | 66  | 12104  | 157 | 12357     | 162 | 19022     | 195 |
| 07078 | 82  | 09120 | 65  | 12106  | 159 | 12358     | 163 | 19023     | 195 |
| 07079 | 82  | 09121 | 65  | 12107  | 158 | 12361     | 172 | 19038     | 181 |
| 07153 | 136 | 09122 | 66  | 12108  | 156 | 12452     | 169 | 19052     | 187 |
| 07155 | 136 | 09123 | 66  | 12109  | 155 | 12455*    | 168 | 19088     | 163 |
| 07156 | 133 | 09124 | 65  | 12110  | 156 | 12456     | 168 | 19110     | 195 |
| 07157 | 133 | 09125 | 65  | 12112  | 154 | 12457     | 168 | 19132     | 196 |
| 07158 | 135 | 09126 | 66  | 12112B | 154 | 12460     | 170 | 19133     | 196 |
| 07159 | 135 | 09127 | 66  | 12113B | 157 | 12461     | 170 | 19145     | 196 |
| 07161 | 136 | 09510 | 67  | 12114B | 155 | 12463     | 169 | 19204     | 196 |
| 07162 | 133 | 09511 | 67  | 12151  | 186 | 12464     | 171 | 19209     | 196 |
| 07163 | 135 | 09512 | 67  | 12152  | 186 | 12464B    | 171 | 19216     | 196 |
| 07164 | 136 | 09521 | 68  | 12153  | 186 | 12551     | 165 | 19219     | 197 |
| 07165 | 133 | 09522 | 68  | 12154  | 186 | 12651     | 187 | 19253     | 192 |
| 07169 | 135 | 10052 | 86  | 12155* | 186 | 12652     | 187 | 19379     | 197 |
| 07257 | 137 | 10072 | 86  | 12201  | 184 | 12653     | 187 | 19413     | 193 |
| 07258 | 136 | 10151 | 86  | 12202  | 184 | 12654*    | 187 | 19433     | 193 |
| 07259 | 137 | 10152 | 88  | 12203  | 186 | 12655     | 187 | 19504     | 197 |
| 07260 | 132 | 10171 | 86  | 12204  | 186 | 12657     | 187 | 19806     | 69  |
| 07261 | 132 | 10251 | 88  | 12206  | 183 | 12659     | 187 | 19807     | 69  |
| 07262 | 132 | 10351 | 88  | 12207  | 183 | 12659B    | 187 | 21001     | 197 |
| 07263 | 134 | 10352 | 86  | 12208  | 182 | 12660B    | 187 | 21002     | 197 |
| 07264 | 134 | 10354 | 87  | 12209  | 183 | 12701     | 148 | 21161     | 197 |
| 07265 | 134 | 10355 | 88  | 12210  | 186 | 12701B    | 148 | 2 4215 61 | 194 |
| 07355 | 85  | 10356 | 88  | 12211  | 184 | 12703     | 148 | 2 77665 4 | 194 |
| 07356 | 85  | 10372 | 86  | 12212  | 182 | 12703B    | 148 | UH16004   | 193 |
| 07357 | 81  | 10374 | 87  | 12212B | 182 | 12704     | 69  |           |     |
| 07358 | 83  | 10451 | 88  | 12213  | 184 | 13001 1/2 | 194 |           |     |

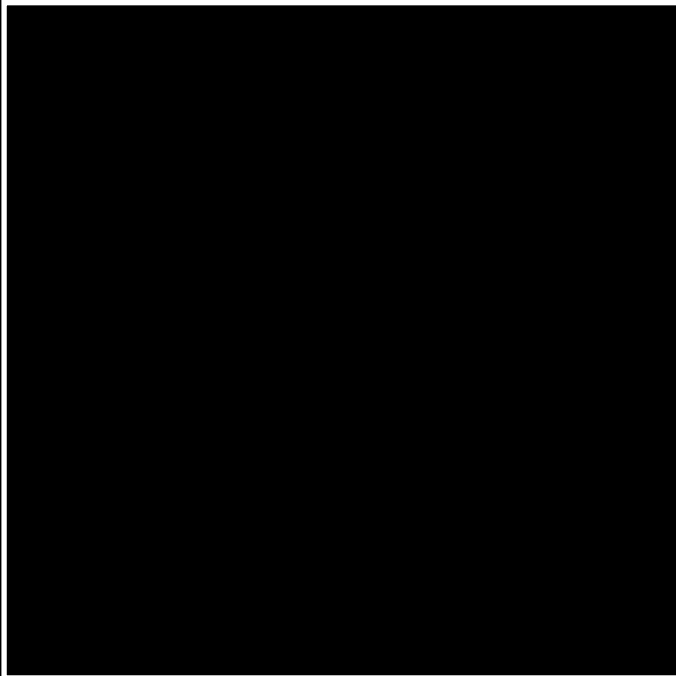

**HERZ d.o.o.**

Grmaška cesta 3  
1275 Šmartno pri Litiji  
T: +386 (0)1 896 21 02  
F: +386 (0)1 896 21 40  
E: [info@herz.si](mailto:info@herz.si)  
W: [www.herz.taps.com](http://www.herz.taps.com)